

TS600 Series Programmable Controller User Manual



Preface

Overview

Thank you for choosing INVT TS600 series programmable controller (programmable controller for short).

TS600 series programmable controller is new generation of small PLC that INVT independently develops, which supports EtherCAT bus, EtherNet bus, RS485 and high-speed I/O interfaces, and up to 16 local expansion modules. In addition, the programmable controller can be equipped with expansion cards to extend RS232, CANopen, SD card, 4G and other functions.

The manual mainly introduces the installation and wiring of the product, including product information, mechanical installation, and electrical installation.

Read through this manual carefully before installing the programmable controller. For details about the user program development environments and user program design methods, see TS600 Series Programmable Logic Controller Programming and Application Manual and TS600 Series Programmable Logic Controller Command Manual that we issue.

The manual is subject to change without prior notice. Please visit www.invt.com to download the latest manual version.

Readers

Personnel with electrical professional knowledge (such as qualified electrical engineers or personnel with equivalent knowledge).

To obtain the manual

The manual is not delivered with the product. To obtain the PDF file, you can:

- Visit www.invt.com, choose Support > Download, and search keywords to download the manual.
- Use your mobile phone to scan the e-manual platform QR code marked on the product housing, and search keywords to download the manual.

Change history

The manual is subject to change irregularly without prior notice due to product version upgrades or other reasons.

No.	Change description	Version	Release date
1	First release.	V1.0	June 2023
2	Added the descriptions related to the transistor source output models.	V1.1	July 2024

Contents

Preface	i
Overview	i
Readers	i
To obtain the manual	i
Change history	i
Contents	ii
1 Safety precautions	1
1.1 Safety declaration	1
1.2 Safety level definition	1
1.3 Personnel requirements	1
1.4 Safety guidelines	1
2 Product overview	4
2.1 Product nameplate and model	4
2.1.1 Product nameplate and model of transistor sink output	4
2.1.2 Product nameplate and model of transistor source output	4
2.2 Product specifications	6
2.2.1 General specifications	6
2.2.2 DI input specifications	7
2.2.3 DO output specifications	8
2.2.4 RS485 specifications	10
2.2.5 EtherCAT specifications	10
2.2.6 EtherNet specifications	11
2.3 Interface description	11
3 Mechanical installation	15
3.1 Installation environment requirements	15
3.2 Installation and disassembly	15
3.2.1 Installation	15
3.2.2 Disassembly	18
4 Electrical installation	21
4.1 Cable specifications	21
4.2 DI terminal wiring	22
4.3 DO terminal wiring	23
4.3.1 Transistor sink output DO terminal wiring	23
4.3.2 Transistor source output DO terminal wiring	23
4.4 Wiring of power supply terminals	24
4.5 RS485 networking wiring	24
4.6 EtherCAT networking wiring	25

4.7 Ethernet wiring	25
5 Other descriptions.....	26
5.1 Programming tool	26
5.2 Run and stop operations.....	26
5.3 Preventive maintenance	26
5.4 SD card user program and firmware upgrade	26
5.4.1 Generate a PLC application upgrade package	26
5.4.2 SD card upgrading steps.....	27
5.5 SD card firmware upgrade	31
Appendix A Expansion card optional accessories	32
Appendix B Dimension drawings.....	33
B.1 Structural dimensions.....	33

1 Safety precautions



1.1 Safety declaration

Read this manual carefully and follow all the safety precautions before moving, installing, wiring, commissioning and running the programmable controller. Otherwise, equipment damage or physical injury or death may be caused.

We shall not be liable or responsible for any equipment damage or physical injury or death caused due to failure to follow the safety precautions.

1.2 Safety level definition

To ensure personal safety and avoid property damage, you must pay attention to the warning symbols and tips in the manual.

Warning symbols	Name	Description
	Danger	Severe personal injury or even death can result if related requirements are not followed.
	Warning	Personal injury or equipment damage can result if related requirements are not followed.

1.3 Personnel requirements

Trained and qualified professionals: People operating the equipment must have received professional electrical and safety training, and must be familiar with all steps and requirements of equipment installing, commissioning, running and maintaining and capable to prevent any emergencies according to experiences.

1.4 Safety guidelines

General principles	
	<ul style="list-style-type: none"> Only trained and qualified professionals are allowed to carry out related operations. Do not perform wiring, inspection or component replacement when power supply is applied.

Delivery and installation	
	<ul style="list-style-type: none"> Do not install the programmable controller on inflammables. In addition, prevent the programmable controller from contacting or adhering to inflammables. Install the programmable controller in a lockable control cabinet of at least IP20, which prevents the personnel without electrical

Delivery and installation

equipment related knowledge from touching by mistake, since the mistake may result in equipment damage or electric shock. Only personnel who have received related electrical knowledge and equipment operation training can operate the control cabinet.

- Do not run the programmable controller if it is damaged or incomplete.
- Do not contact the programmable controller with damp objects or body parts. Otherwise, electric shock may result.

Wiring



- Fully understand the interface types, specifications, and related requirements before wiring. Otherwise, incorrect wiring cause abnormal running.
- Before power-on for running, ensure that each module terminal cover is properly installed in place after the installation and wiring are completed. This prevents a live terminal from being touched. Otherwise, physical injury, equipment fault or misoperation may result.
- Install proper protection components or devices when using external power supplies for the programmable controller. This prevents the programmable controller from being damaged due to external power supply faults, overvoltage, overcurrent, or other exceptions.

Commissioning and running

- Before power-on for running, ensure that the working environment of the programmable controller meets the requirements, the input power specifications meet the requirements, the wiring is correct, and a protection circuit has been designed to protect the programmable controller so that the programmable controller can run safely even if an external device fault occurs.
- For modules or terminals requiring external power supply, configure external safety devices such as fuses or circuit breakers to prevent damage caused due to external power supply or device faults.

Maintenance and component replacement

- During maintenance and component replacement, take measures to prevent screws, cables and other conductive matters from falling into the internal of the programmable controller.

Disposal	
	<ul style="list-style-type: none">• This programmable controller contains heavy metals. Dispose of a scrap programmable controller as industrial waste.
	<ul style="list-style-type: none">• Dispose of a scrap programmable controller separately at an appropriate collection point but not place it in the normal waste stream.

2 Product overview

2.1 Product nameplate and model

2.1.1 Product nameplate and model of transistor sink output

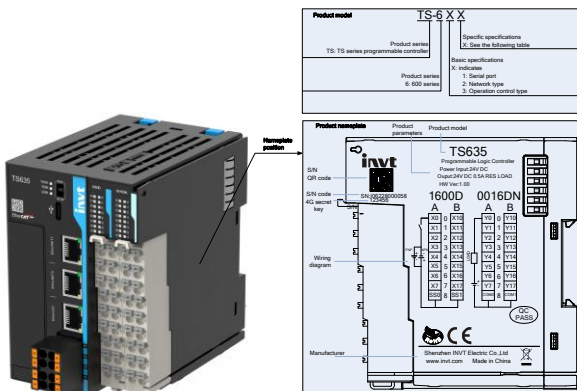

2.1.2 Product nameplate and model of transistor source output

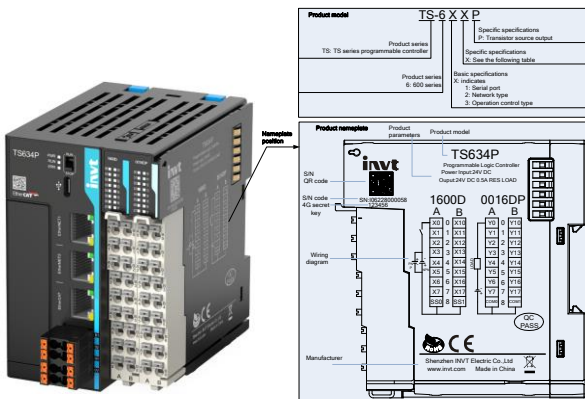

Model	Specifications
TS611	16 inputs and 16 transistor outputs, 1×USB (Type-C), 2×RS485, 8 200k inputs, and 16 200k outputs (sink output), support 8 pulse axes
TS621	16 inputs and 16 transistor outputs, 1×USB (Type-C), 2×RS485, 8 200k inputs, 16 200k outputs (sink output), support 8 pulse axes, 2×EtherNet
TS621P	16 inputs and 16 transistor outputs, 1×USB(Type-C), 2×RS485, 8 200k inputs, 16 200k outputs (source output), support 8 pulse axes, 2×EtherNet
TS633	16 inputs and 16 transistor outputs, 1×USB (Type-C), 2×RS485, 8 200k inputs, 8 200k outputs (sink output), support 4 pulse axes, 2×EtherNet, 1×EtherCAT, support 8 axes (EtherCAT bus) in maximum
TS633P	16 inputs and 16 transistor outputs, 1×USB(Type-C), 2×RS485, 8 200k inputs, 8 200k outputs (source output), support 4 pulse axes, 2×EtherNet, 1×EtherCAT, support 8 axes (EtherCAT bus) in maximum
TS634	16 inputs and 16 transistor outputs, 1×USB (Type-C), 2×RS485, 8 200K inputs, 8 200K outputs (sink output), support 4 pulse axes, 2×EtherNet, 1×EtherCAT, and 16 axes (EtherCAT bus) in maximum
TS634P	16 inputs and 16 transistor outputs, 1×USB (Type-C), 2×RS485, 8 200k inputs, 8 200k outputs (source output), support 4 pulse axes, 2×EtherNet, 1×EtherCAT, and 16 axes (EtherCAT bus) in maximum
TS635	16 inputs and 16 transistor outputs, 1×USB(Type-C), 2×RS485, 8 200k inputs, 8 200k outputs (sink output), support 4 pulse axes, 2×EtherNet, 1×EtherCAT, support 32 axes (EtherCAT bus) in maximum

2.2 Product specifications

2.2.1 General specifications

Item	TS635	TS634	TS634P	TS633	TS633P	TS621	TS621P	TS611
EtherNet interface	2 channels	2 channels	2 channels	2 channels	2 channels	2 channels	2 channels	-
EtherCAT interface	1 channel	1 channel	1 channel	1 channel	1 channel	-	-	-
Max. number of EtherCAT bus axes	32 axes	16 axes	16 axes	8 axes	8 axes	-	-	-
Max. number of pulse axes	4	4	4	4	4	8	8	8
RS485 bus	2 channels, supporting Modbus RTU master/slave function							
EtherNet bus	Support ModbusTCP/UDP, program upload and download, and firmware upgrade							
USB interface	1 channel, Type-C interface, supporting program upload and download, and firmware upgrade							
DI input	16 inputs, including 8 high-speed inputs of 200kHz, support 4 encoder axes or 8 channels of 1PH counting							
DO output	16 outputs, transistor sink or source output, and each axis pulse has a maximum output frequency of 200kHz. Note: If you use the programmable controller when the frequency exceeds 10kHz, the load current shall be greater than 12mA.							
Input power	24V DC (-15% – +20%)/1A, supporting reversal protection							
Power dissipation of a single unit	<3W							
Backplane bus power supply	5V/2.5A							
Power-failure retention function	Supported (retention by the internal flash)  Note: (no protection within 30 seconds after power-on)							
Real-time clock	Supported (CR2032 battery is optional, and the duration of the real-time clock without batteries is about four days)							
Local expansion modules	Up to 16, disallowing hot plug.							

Item	TS635	TS634	TS634P	TS633	TS633P	TS621	TS621P	TS611
Local expansion card	One expansion card, supporting SD card, CANopen card, RS232 card, 4G IoT card and so on							
Program language	LD, SFC, IL							
Program download	USB port, Ethernet interface, SD card (expansion card), and remote download (expansion card)							
Program data capacity	200K step user program 2MByte user-defined variables, in which 128kByte support the power-failure retention function. Approx. 150K soft components, in which the soft component data numbered 1000 or higher support the power-failure retention function.							
Product weight	About 0.4kg							
Product dimensions	For details, see Appendix A Expansion card optional accessories.							

 **Note:**

- “-” indicates that it is not supported.
- This product supports the power supply of PC USB interface dedicated to the PLC (without connecting to the expansion module), and the supply current of the PC USB interface shall be not less than 1A.
- If the service power of the PC USB interface is insufficient, resulting in the fact that the PLC cannot be booted up or burn the program normally, you shall disconnect the USB interface first, change to use 24VDC power supply for the PLC, and then connect to the USB interface.

2.2.2 DI input specifications

Item	Description
Input type	Digital input
Number of input channels	16 channels
Input mode	Source and sink type
Input voltage class	24V DC (-10%~+10%)
Input current	X0~X7 channels: Input current is 13.5mA (typical value) when the channel is ON; input current is less than 1.7mA when the channel is OFF. X10~X17 channels: Input current is 4.7mA (typical value)

Item	Description
	when the channel is ON; input current is less than 0.9mA when the channel is OFF.
Max. input frequency	X0–X7 channels: 200kHz; X10–X17 channels: 200kHz
Input resistance	Typical value of X0–X7 channels: 1.7k Ω ; Typical value of X10–X17 channels: 5.1k Ω .
ON voltage	$\geq 15\text{VDC}$
OFF voltage	$\leq 5\text{VDC}$
Software filter time	High speed: 0.25 μs –16383 μs Low speed: 1ms–65535ms
Isolation method	Capacitive isolation
Common terminal method	8CH/group
Input action display	When the input is in the driving state, the input indicator is on (software control).

2.2.3 DO output specifications

Item	Description
Output type	TS6XX: Transistor NPN sink output TS6XXP: Transistor PNP source output
Number of output channels	16 channels
Output voltage class	24VDC (-10%–+10%)
Output load (resistance)	A maximum of 0.5A/point, 2A/group at room temperature
Output load (inductance)	A maximum of 7.2W/point, 24W/group at room temperature
Output load (light)	A maximum of 5W/point, 18W/8 group at room temperature
Hardware response time	$\leq 2\mu\text{s}$
Load current requirement	If the output frequency is greater than 10kHz, the load current is greater than or equal to 12mA.
Max. output frequency	Resistive load of 200kHz, inductive load of 0.5Hz, lamp load of 10Hz
Leakage current at OFF	Below 30 μA (24V typical voltage)

Item	Description
Max. residual voltage at ON	$\leq 0.5\text{VDC}$
Isolation method	Capacitive isolation
Common terminal method	8CH/group
Short-circuit protection function	Supported
External inductive load requirement	When connecting to an external inductive load, it is required to connect a flyback diode. The sink output in the wiring diagram is shown in Figure 2-1, and the source output is shown in Figure 2-2.
Output action display	When the output is valid, the output indicator is on (software control).
Output current derating	When the ambient temperature rises, the output for each point and group needs to be derated. When the ambient temperature is 55°C , the output for each point needs to be derated to 70%, and the total current at each group of common terminal cannot exceed 1A.

Figure 2-1 Diagram for connecting sink output inductive load to flyback diode

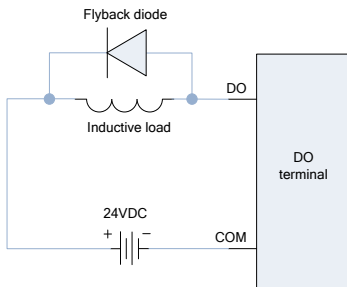

Figure 2-2 Diagram for connecting source output inductive load to flyback diode

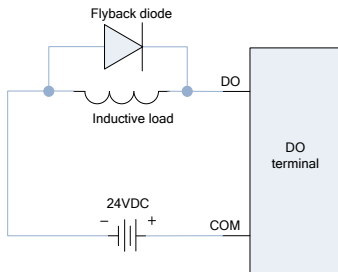
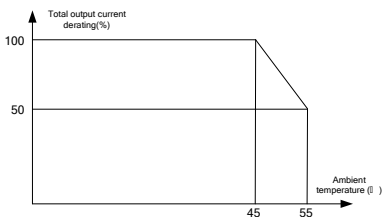

Figure 2-3 Output current derating curve



2.2.4 RS485 specifications

Item	Description
Supported channels	2 channels
Hardware interface	Pluggable terminal (sharing the 2×4PIN terminal with the power supply)
Isolation method	No isolation
Terminal resistor	Built-in terminal resistor, you can choose whether to connect it through the DIP switch on the side.
Number of slave nodes	Each channel supports up to 31 slaves.
Communication baud rate	9600bps, 19200bps, 38400bps, 57600bps and 115200bps
Input protection	Support 24V mis-insertion protection

2.2.5 EtherCAT specifications

Item	Description
Communication protocol	EtherCAT
Supported service	CoE (PDO/SDO)
Synchronization method	Distributed clocks for the servo; Input and output synchronization for IO
Physical layer	100BASE-TX
Baud rate	100Mbps (100Base-TX)
Duplex mode	Full duplex
Topology structure	Linear topology structure
Transmission medium	Category-5 or higher double-shielded network cables

Item	Description
Transmission distance	Less than 100m between two nodes
Number of slaves	Up to 72 slaves
EtherCAT frame length	44 bytes–1498 bytes
Process data	Up to 1486 bytes contained in a single Ethernet frame

2.2.6 EtherNet specifications

Item	Description
Communication protocol	Standard Ethernet protocol
Physical layer	100BASE-TX
Baud rate	100Mbps (100Base-TX)
Duplex mode	Full duplex
Topology structure	Linear topology structure
Transmission medium	Category-5 or higher double-shielded network cables
Transmission distance	Less than 100m between two nodes

2.3 Interface description

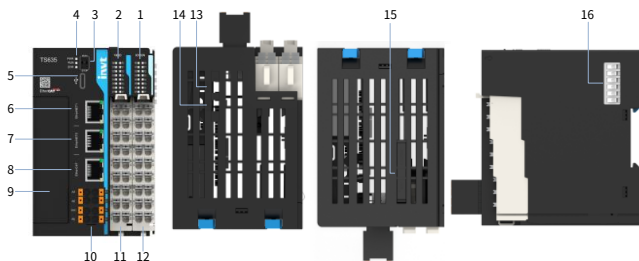

No.	Port type	Interface sign	Definition	Description
1	I/O indicator	0016DN (sink type)	IO state display	On: The output is valid. Off: No output.

No.	Port type	Interface sign	Definition	Description
		0016DP (source type)		
2	I/O indicator	1600D	IO state display	On: The input is valid. Off: The input is invalid.
3	Start/stop DIP switch	RUN	User program running state	Turn to RUN: The user program runs. Turn to STOP: The user program stops.
		STOP		
4	Running state indicator	PWR	Power state display	On: The power supply is normal. Off: The power supply is abnormal.
		RUN	Running state display	On: The user program is running. Off: The user program stops.
		ERR	Running error state display	On: A serious error occurs. Blink: A general error occurs. Off: No error occurs.
5	Type-C interface		Communication between USB and PC	Used for program download and debugging.
6	Ethernet interface	EtherNet1	Ethernet communication interface	Default IP: 192.168.1.10
7	Ethernet interface	EtherNet2	Ethernet communication interface	Default IP: 192.168.2.10
8	EtherCAT interface	EtherCAT	EtherCAT communication interface	-
9	Expansion card slot	-	Expansion card slot, used for function extension.	For optional accessories of the expansion cards, see Appendix A Expansion card optional accessories.

No.	Port type	Interface sign	Definition	Description
10	Power supply terminals	A1	Channel 1 485 communication signal+	-
		B1	Channel 1 485 communication signal-	-
		A2	Channel 2 485 communication signal+	-
		B2	Channel 2 485 communication signal-	-
		GND	485 communication signal reference ground	-
		24V	DC 24V power supply +	-
		0V	DC 24V power supply -	-
		PE	Protection ground	-
11	DI input	-	16 inputs	For details, see section 4.2 DI terminal wiring.
12	DO output	-	16 outputs	For details, see section 4.3 DO terminal wiring.
13	Terminal resistor DIP switch 1	485R1	RS485 bus 1 is equipped with a built-in 120Ω terminal resistor DIP switch.	Turn to 0: The built-in terminal resistor is disconnected. Turn to 1: The built-in terminal resistor is connected.
14	Terminal resistor DIP switch 2	485R2	RS485 bus 2 is equipped with a built-in 120Ω terminal resistor DIP switch.	Turn to 0: The built-in terminal resistor is disconnected. Turn to 1: The built-in terminal resistor is connected.

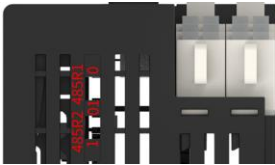
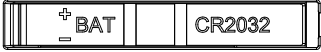
No.	Port type	Interface sign	Definition	Description
				
15	Button battery container	CR2032	RTC clock button battery container	Applicable to CR2032 button battery. Note: The product is not equipped with the button battery as standard configuration by default.
				
16	Backplane connector	-	Local expansion backplane bus	Connected to the local expansion modules.

3 Mechanical installation

3.1 Installation environment requirements

The operability, maintainability, and environment resistance shall be fully considered when the product is installed on the DIN rail.

Item	Specifications
IP rating	IP20
Pollution level	Level 2: Generally, there is only non-conductive pollution, but the occasional situation that transient conductivity caused by condensation must be taken into account.
Altitude	2000m (80kPa)
Overcurrent protection device	1.1A fuse
Max. working temperature	45°C in full load Derating is required if the ambient temperature reaches 55°C. For details, see Figure 2-3.
Storage temperature and humidity range	Temperature: 20°C–60°C; relative humidity: less than 90% and no condensation
Transportation temperature and humidity range	Temperature: 40°C–70°C; relative humidity: less than 95% and no condensation
Working temperature and humidity range	Temperature: 20°C–55°C; relative humidity: less than 95% and no condensation

3.2 Installation and disassembly

3.2.1 Installation

3.2.1.1 Master installation

The installation steps are as follows:

Align the master to the DIN rail, and press it inwards until the master and the DIN rail are clamped (there is an obvious sound of clamping after they are installed in place).

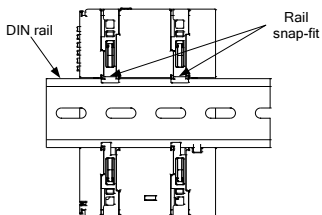
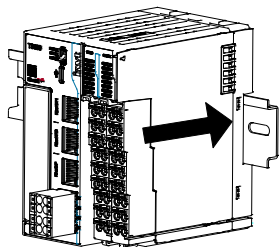

Note: The master uses DIN rail for installation.

3.2.1.2 Installation between the master and the module

The installation steps are as follows:

Align the module with the connecting rail to the master slide rail and push inward until the module and the DIN rail are clamped (there is an obvious sound of clamping after they are installed in place).

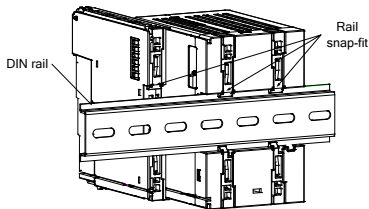
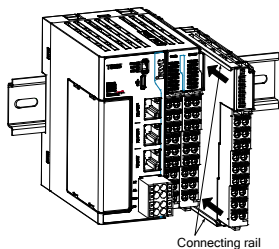

Note: The master and the module use DIN rail for installation.

3.2.1.3 Expansion card installation

Take out the cover before installing the expansion card. The installation steps are as follows.

Step 1 Use a tool to gently pry the cover snap-fits on the side of the product (in sequence of position 1 and 2), and take out the cover horizontally to the left.

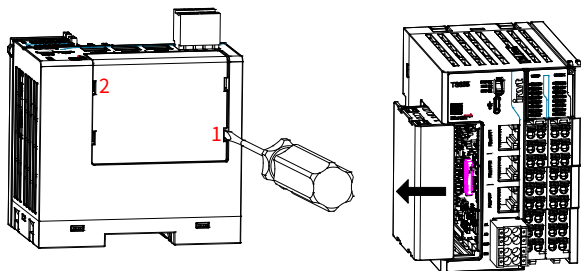

Step 2 Slide the expansion card into the guide slot in parallel, then press the clip positions on the upper and lower sides of the expansion card until the expansion card is clamped (there is an obvious sound of clamping after they are installed in place).

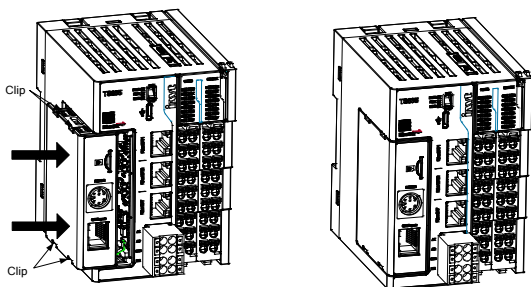

3.2.1.4 Button battery installation

Step 1 Open the button battery cover.

Step 2 Push the button battery into the button battery slot in the correct direction, and close the button battery cover.

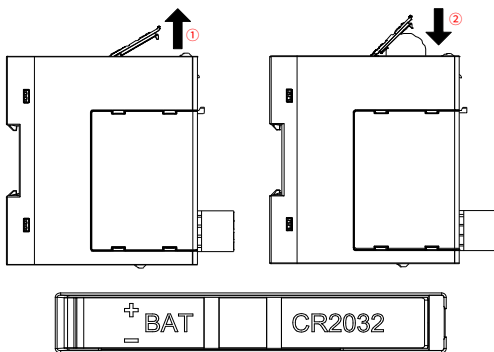
**Note:**

- Please note the anode and cathode of the battery.
- When a battery is installed and the programming software reports an alarm of low battery, the battery needs to be replaced.

3.2.2 Disassembly

3.2.2.1 Master disassembly

The disassembly steps are as follows:

Step 1 Use a screwdriver or similar tools to pry up the rail snap-fit.

Step 2 Pull the module straight ahead at the snap-fit position (raised part).

Step 3 Press the top of the rail snap-fit into place.

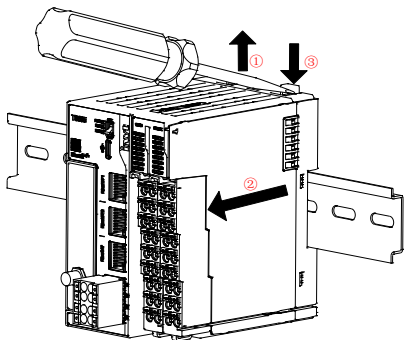

3.2.2.2 DI and DO terminal disassembly

The disassembly steps are as follows:

Step 1 Press down the clip on the top of the terminal (raised part).

Step 2 Press and pull out the terminal simultaneously.

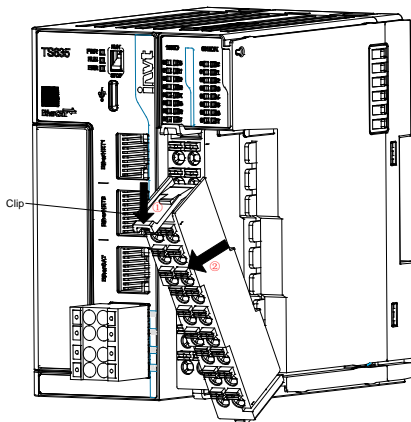

3.2.2.3 Button battery disassembly

The disassembly steps are as follows:

Step 1 Open the button battery cover. (For details, see section 3.2.1.4 Button battery installation)

Step 2 Disassemble the DI terminal. (For details, see section 3.2.2.2 DI and DO terminal disassembly)

Step 3 Use a small screwdriver to gently push out the button battery, as shown in the following figure.

Step 4 Take out the battery and close the button battery cover.

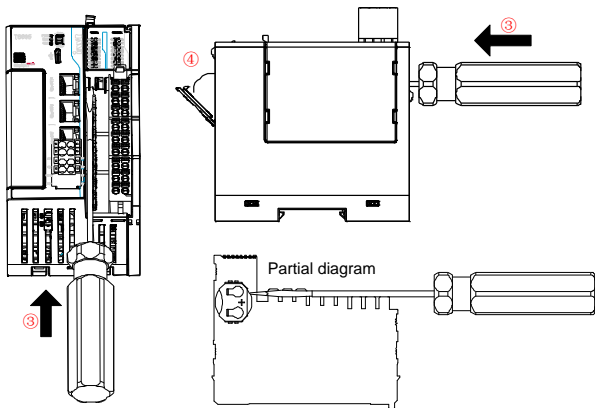

4 Electrical installation

4.1 Cable specifications

Table 4-1 Single cable dimensions

Applicable wire diameter		Tube-type crimp
Chinese standard/mm ²	American standard/AWG	
0.3	22	
0.5	20	
0.75	18	
1.0	18	
1.5	16	

Figure 4-1 Ethernet cable diagram



Pin	Signal	Signal direction	Signal description
1	TD+	Output	Data transmission +
2	TD-	Output	Data transmission-
3	RD+	Input	Data receiving +
4	-	-	Unused
5	-	-	Unused
6	RD-	Input	Data receiving-
7	-	-	Unused
8	-	-	Unused

4.2 DI terminal wiring

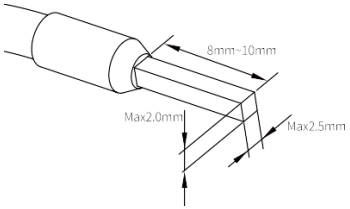
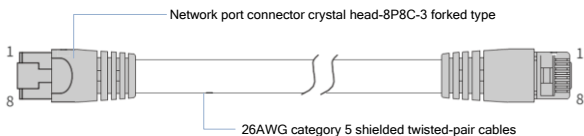
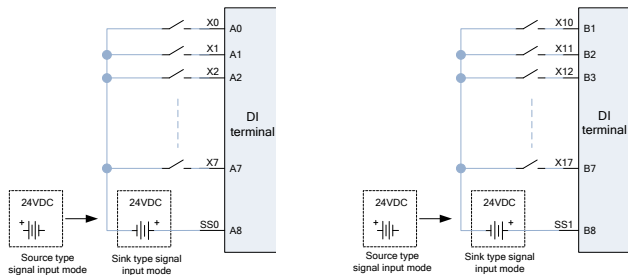

Sign	Signal description	Sign	Signal description
A0	DI0 channel input	B0	DI10 channel input
A1	DI1 channel input	B1	DI11 channel input
A2	DI2 channel input	B2	DI12 channel input
A3	DI3 channel input	B3	DI13 channel input
A4	DI4 channel input	B4	DI14 channel input
A5	DI5 channel input	B5	DI15 channel input
A6	DI6 channel input	B6	DI16 channel input
A7	DI7 channel input	B7	DI17 channel input
A8	DI0–DI7 channel common terminal	B8	DI10–DI17 channel common terminal

Note:

- The total length of high-speed IO interface connection cable shall be within 3 meters.
- During cable routing, separate the connection cables from other cables that transmit strong interference signals, such as power cables (high voltage and large current), but not bind the connection cables with the latter together. In addition, avoid parallel routing.

4.3 DO terminal wiring

4.3.1 Transistor sink output DO terminal wiring

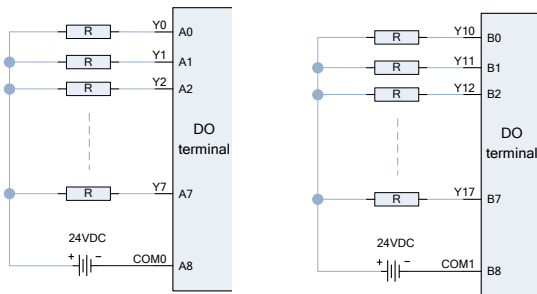

4.3.2 Transistor source output DO terminal wiring

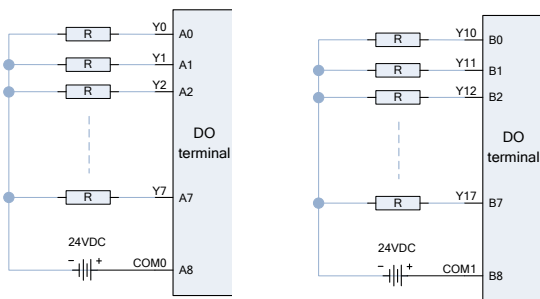

Sign	Signal description	Sign	Signal description
A0	DO0 channel output	B0	DO10 channel output
A1	DO1 channel output	B1	DO11 channel output
A2	DO2 channel output	B2	DO12 channel output
A3	DO3 channel output	B3	DO13 channel output
A4	DO4 channel output	B4	DO14 channel output
A5	DO5 channel output	B5	DO15 channel output
A6	DO6 channel output	B6	DO16 channel output

Sign	Signal description	Sign	Signal description
A7	DO7 channel output	B7	DO17 channel output
A8	DO0–DO7 channel common terminal	B8	DO10–DO17 channel common terminal

Note: When connecting to an external inductive load, it is required to connect a flyback diode. The wiring diagram is shown in section 2.2.3 DO output specifications.

4.4 Wiring of power supply terminals

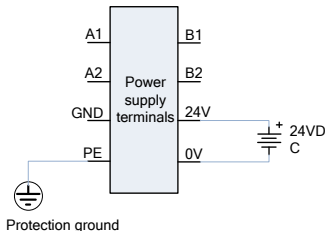

4.5 RS485 networking wiring

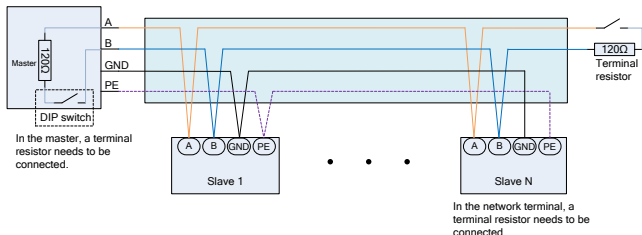

Note:

- It is recommended that the shielded twisted pair be used as the RS485 bus. 485A and 485B use twisted pair connection.
- Each end of the bus connects a 120Ω terminal resistor to prevent signal reflection.
- For all nodes, the reference grounds of the 485 signal are connected together.
- The distance from the bus to each node must be less than 3 meters.

4.6 EtherCAT networking wiring

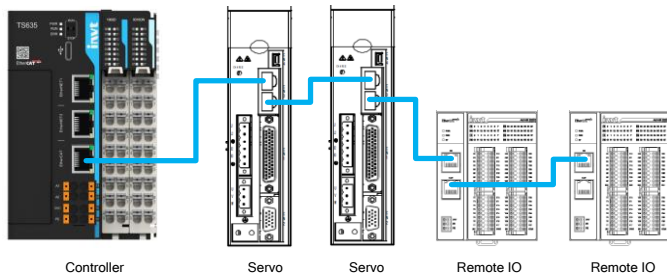

Note:

- It is required to use double-shielded twisted-pair cables of category 5, plastic injection moulded and iron shelled, compliant with EIA/TIA568A, EN50173, ISO/IEC11801, EIA/TIA bulletin TSB, and EIA/TIA SB40-A&TSB36.
- The network cable must pass the conductivity test 100%, without short circuit, opened circuit, dislocation or poor contact.
- When connecting the network cable, hold the crystal head of the cable and insert it into the Ethernet interface (RJ45 interface) until it makes a click sound.
- When removing the installed network cable, press the tail mechanism of the crystal head and pull out it from the product horizontally.

4.7 Ethernet wiring

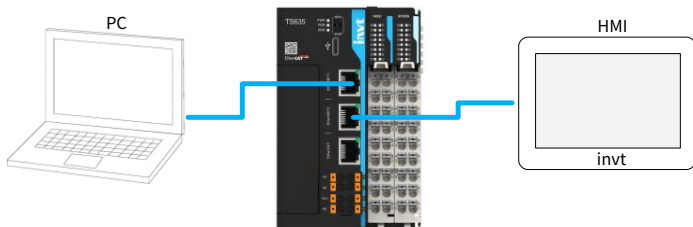

5 Other descriptions

5.1 Programming tool

Programming tool: Auto Station Pro.

To obtain the programming tool: Visit www.invt.com, choose Support > Download, and search keywords to download the programming tool.

5.2 Run and stop operations

After programs are written to the PLC, perform startup and shutdown as follows.

- When running the system, set the system to RUN state and ensure that the RUN indicator is on (yellow-green).
- When stopping the system, set the system to STOP state (the system also can be stopped by the upper computer background).

5.3 Preventive maintenance

- Clean the programmable controller regularly, and prevent foreign matters falling into the controller.
- Ensure good ventilation and heat dissipation conditions for the controller.
- Formulate maintenance instructions and regularly test the controller.
- Regularly check the wiring and terminals to ensure that they are securely fastened.

5.4 SD card user program and firmware upgrade

5.4.1 Generate a PLC application upgrade package

Use a SD card to upgrade the PLC application, PLC firmware (firmware files provided by the manufacturer), and system firmware (firmware files provided by the manufacturer). When upgrading the PLC application, you need to follow the following steps to generate the PLC application upgrade package first. Use a SD card to upgrade PLC application function, which means that PLC project can compile, generate the download project files, which is convenient for users to download without opening the original project. Use a SD card to batch update or upgrade PLC project. Update PLC project with AutoStation Pro in the background. Before downloading the project file, you need to generate and download the project file through Auto Station Pro in the background. The specific operation steps are as follows:

Step 1 Open the PLC project and click **PLC>PLC executable package (A)>Generate** menu bar. The following dialog box pops up.

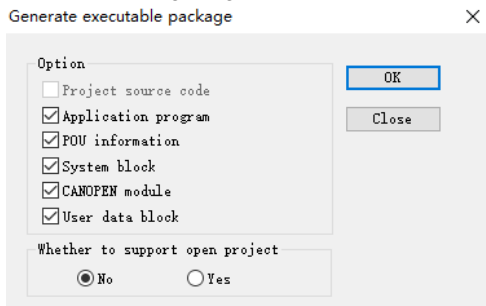

Step 2 Set the attributes of the downloaded file in the **Generate executable package** interface that pops up in the system, and then click OK.

- Option: Check **Project source code**, **Application program**, **POU information**, **System block** and **User data block**.
 - Project source code: Support to open the project, required
 - Application program: Executable applications
 - POU information: POU information
 - System block: System related data configuration
 - User data block: User related data configuration
- Whether to support opening the project, check: "No", "Yes".
 - No: The generation package file cannot open application project through AutoStation Pro, source upload is not supported, and the file format is *.cmf.
 - Yes: The generate package file can open the application project through AutoStation Pro, the source code upload is supported, and the file format *.upcmf.

Step 3 Generate the PLC application name in the standard format of TS*_PROJECT_*.cmf or TS*_PROJECT_*.upcmf file for customer upgrade, where * is variable multiple characters, the former * is the product model, and the latter * is usually the project name.

5.4.2 SD card upgrading steps

Step 1 Prepare a SD card with the storage capacity up to 32G, and it cannot be partitioned.

Step 2 Create the directory to be upgraded in SD card root directory.

- The PLC application upgrade directory is named PLCProject
- The PLC firmware upgrade directory is named PLCFirmware
- The system firmware upgrade directory is named SYSFirmware

 PLCFirmware	2/22/2024 2:15 PM	File folder
 PLCProject	2/22/2024 2:26 PM	File folder
 SYSFirmware	2/22/2024 2:15 PM	File folder

 **Note:** Only the directories that need to be upgraded are created, and the directories that do not need to be upgraded may not be created.

Step 3 Copy the PLC application package, or PLC firmware, or system firmware to the corresponding directory.

The standard format of PLC application name is: TS*_PROJECT_*.cmf or TS*_PROJECT_*.upcmf, where * is variable multiple characters, the former * is the product model, and the latter * is usually the project name;

 **Note:** This file is generated by Auto Station Pro.

The standard format of PLC firmware name is: TS600_MCU_*.tar.gz, where * is variable multiple characters, usually 5 digits to indicate the version.

 **Note:** This firmware file is provided by the manufacturer.

The standard format of system firmware name is: TS600_ARM_*.patch, where * is variable multiple characters, usually 5 digits to indicate the major version and P+3 digits for the patch version.

 **Note:** This firmware file is provided by the manufacturer.

Step 4 There is only one file in each directory that needs to be upgraded. More than one file may cause unexpected problems.

- **PLC firmware file**

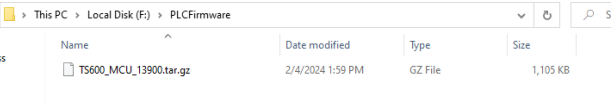

Name	Date modified	Type	Size
 TS600_MCU_13900.tar.gz	2/4/2024 1:59 PM	GZ File	1,105 KB

- **System firmware file**

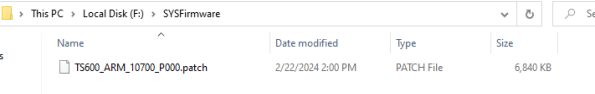

Name	Date modified	Type	Size
 TS600_ARM_10700_P000.patch	2/22/2024 2:00 PM	PATCH File	6,840 KB

- **Application package file**

Name	Date modified	Type	Size
TS635_PROJECT_TS600_PROIECT_liangwanmask.cmf	2/22/2024 2:18 PM	CMF File	18 KB
TS635_PROJECT_TS600_PROIECT_liangwanmask.upcmf	2/22/2024 2:18 PM	UPCMF File	35 KB

Step 5 Power off the PLC controller, and insert a SD card.

Step 6 Power up the PLC controller, and wait for the upgrade to complete. If the upgrade is successful, the run indicator will flash for about 4 seconds, then the error indicator will flash slowly, waiting for the controller to turn off power.

Step 7 Power off the PLC controller, remove the SD card, and wait for the upgrade to complete. You can check whether the SD card upgrade is successful through the log.

- **The successful upgrade of PLC firmware and system firmware is as shown in the figure below.**

33	2023-09-21 13:34:26	0	0	INFO:PLC firmware upgrade success
32	2023-09-21 13:34:24	0	0	INFO:system firmware upgrade success
31	2023-09-21 13:34:16	0	0	INFO:TS600 start run...

- **If the upgrade fails, there is also a corresponding log for description.**

65	2023-09-22 11:38:15	0	0	INFO:system firmware upgrade fail! because of: 0x101
66	2023-09-22 11:38:15	0	0	INFO:plc firmware upgrade fail! because of: 0x111

Note: SD card upgrade is only detected during power-on, and upgrade is no longer detected during operation. After successful upgrade, remove the SD card in time, otherwise the controller will not run normally. Do not remove the SD card or power off during the upgrade process, otherwise unexpected errors may be caused.

Upgrade success and failure are displayed in the log file through information. If the upgrade fails, the controller runs normally and will not report errors. You need to view the reasons for the upgrade failure in the log file.

Table 5-1 System firmware upgrade failure error code

Upgrade failure error code	Cause of failure	Solution
0x101	The patch file could not be found	Check whether the file exists and whether the file has a standard name
0x102	Failed to get local version number	Check system files

Upgrade failure error code	Cause of failure	Solution
0x103	Patch version is too low to upgrade	System version greater than or equal to version 1.05
0x104	Replication failed	Usually caused by insufficient storage space and insufficient memory
0x105	Check failure	Check the file for corruption

Table 5-2 PLC firmware upgrade failure error code

Upgrade failure error code	Cause of failure	Solution
0x111	PLC firmware file not found	Check whether the file exists and whether the file has a standard name
0x112	Failed to copy file	Usually caused by insufficient storage space and insufficient memory
0x113	Failed to create directory extract file	General file corruption
0x114	Script execution failed	Usually the file is corrupted, or the firmware does not meet manufacturer standard

Table 5-3 PLC application upgrade failure error code

Upgrade failure error code	Cause of failure	Solution
0x121	Upgrade package file not found	Check whether the file exists and whether the file has a standard name.
0x122	Failed to copy file	Usually caused by insufficient storage space and insufficient memory
0x124	Failed to open the file	Usually the upgrade package file is corrupt or the file does not exist

Upgrade failure error code	Cause of failure	Solution
0x125	Failed to allocate memory	Usually caused by insufficient memory
0x126	File header error	Usually the upgrade package file is corrupt or in a non-standard upgrade package format
0x127	Failed to write file	Usually caused by file unpacking failure, or there is a system problem
0x128	CRC verification failed	Usually files corrupt, or in non-standard upgrade package format

5.5 SD card firmware upgrade

Step 1 Store the upgrade file in the root directory of the Micro SD card.



Step 2 Install the Micro SD card in the expansion card slot first, and then on the product.

Step 3 Power on the product, the RUN indicator flash quickly (4Hz frequency) for 3s and then stay on, it indicates that the firmware is being upgraded. When the RUN indicator returns to flash slowly (1Hz frequency), it indicates that the firmware upgrade is completed.

Step 4 Remove the Micro SD card and re-power the product.

 **Note:** Power off the product before installing the TF expansion card.

Appendix A Expansion card optional accessories

No.	Model	Specifications
1	TS-CAN-232	<p>Support Micro SD card, CANopen bus, and one RS232</p>  A green printed circuit board (PCB) expansion card housed in a black metal casing. The front panel features a Micro SD card slot at the top, an RS232 serial port in the middle, and a CANopen bus connector at the bottom. The PCB is populated with various electronic components like capacitors and integrated circuits.
2	TS-4G	<p>Support Micro SD card and 4G IoT</p>  A green printed circuit board (PCB) expansion card housed in a black metal casing. The front panel features a Micro SD card slot at the top, followed by four status LEDs labeled '4G', '4G', '4G', and '4G', and a 4G IoT antenna connector at the bottom. The PCB is populated with various electronic components like capacitors and integrated circuits.

Appendix B Dimension drawings

B.1 Structural dimensions

Figure B-1 Product dimension diagram (unit: mm)

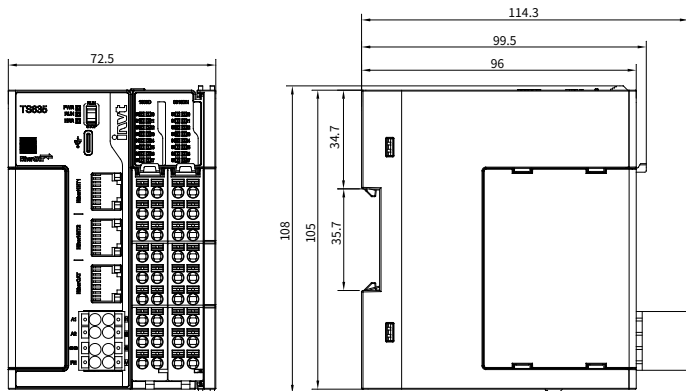

Your Trusted Industry Automation Solution Provider



Shenzhen INVT Electric Co., Ltd.

Address: INVT Guangming Technology Building, Songbai Road, Matian,
Guangming District, Shenzhen, China

INVT Power Electronics (Suzhou) Co., Ltd.

Address: No. 1 Kunlun Mountain Road, Science & Technology Town,
Gaixin District, Suzhou, Jiangsu, China

Website: www.invt.com



INVT mobile website



INVT e-manual



6 6 0 0 1 - 0 1 1 6 7