

INVT Flex Series I/O System

User Manual



Preface

Overview

Thank you for choosing INVT Flex series I/O system.

INVT Flex series I/O system is a flexible, reliable, and efficient signal transmission system with a more reliable structural design. The system is able to access to multiple standard communication networks, respond in microseconds, and equipped with rich signal modules to meet various industrial automation needs while saving cabinet space, helping you develop more competitive personalized solutions.

Target audience

Personnel with electrical professional knowledge (such as qualified electrical engineers or personnel with equivalent knowledge).

About documentation obtaining

In addition to this user guide, you can also obtain product documentation and technical support from our website:

Visit www.invt.com, choose **Support** > **Download**, enter a keyword, and click **Search**.

Change history

The manual is subject to change irregularly without prior notice due to product version upgrades or other reasons.

No.	Change description	Version	Release date
1	First release.	V1.0	September 2023

Contents

1 Safety precautions	1
1.1 What this chapter contains.....	1
1.2 Safety level definition	1
1.3 Personnel requirements.....	1
1.4 Safety guidelines.....	1
2 Communication coupler specifications	4
2.1 EtherCAT communication coupler.....	4
2.1.1 FK1100.....	4
2.2 PROFINET communication coupler	7
2.2.1 FK1200.....	7
3 I/O module specifications	11
3.1 Digital input module.....	11
3.1.1 FL1001 (1600D).....	11
3.2 Digital output module (Source type)	15
3.2.1 FL2002 (0016DP)	15
3.3 Digital output module (Sink type).....	19
3.3.1 FL2102 (0016DN)	19
3.4 Digital output module (Relay)	23
3.4.1 FL2201 (0008DR)	23
3.5 Analog input module	26
3.5.1 FL3003 (4AD)	26
3.6 Analog output module.....	30
3.6.1 FL4003 (4DA)	30
3.7 Temperature detection module (Thermal resistor)	34
3.7.1 FL3103 (4PT).....	34
3.8 Temperature detection module (Thermocouple)	38
3.8.1 FL3203 (4TC).....	38
4 Installation.....	42
4.1 Preparing.....	42
4.1.1 Installation precautions	42
4.1.2 Installation environment and site.....	42
4.1.3 Installation space.....	43
4.2 Installation dimensions.....	43
4.2.1 Communication coupler.....	43
4.2.2 I/O module	45
4.3 DIN rail model selection	46
4.4 Installation	46
4.5 Disassembly	48
5 Wiring	50
5.1 Wiring requirements.....	50
5.2 Grounding requirements.....	50
5.3 Cable specifications.....	50
5.4 Terminal definition and wiring.....	51
5.4.1 Communication coupler (of EtherCAT/PROFINET)	51
5.4.2 Digital input module.....	52

5.4.3 Digital output module (Source type)	53
5.4.4 Digital output module (Sink type).....	54
5.4.5 Digital output module (Relay)	55
5.4.6 Analog input module	56
5.4.7 Analog output module.....	57
5.4.8 Temperature detection module (Thermal resistor)	58
5.4.9 Temperature detection module (Thermocouple)	59
6 Product programming application	60
6.1 Communication coupler.....	60
6.1.1 FK1100 EtherCAT communication coupler.....	60
6.1.2 FK1200 PROFINET communication coupler	64
6.2 I/O module	71
6.2.1 FL1001 (1600D) digital input module	71
6.2.2 FL2002 (0016DP) digital output module (Source type)	74
6.2.3 FL2102 (0016DN) digital output module (Sink type)	77
6.2.4 FL2201 (0008DR) digital output module (Relay).....	81
6.2.5 FL3003 (4AD) analog input module.....	84
6.2.6 FL4003 (4DA) analog output module	87
6.2.7 FL3103 (4PT) temperature detection module (Thermal resistor).....	91
6.2.8 FL3203 (4TC) temperature detection module (Thermocouple).....	95
7 Fault code	101

1 Safety precautions



1.1 What this chapter contains

Read this manual carefully and follow all safety precautions before moving, installing, operating and servicing the VFD. Otherwise, equipment damage or physical injury or death may be caused.

We shall not be liable or responsible for any equipment damage or physical injury or death caused due to failure to follow the safety precautions.

1.2 Safety level definition

To ensure personal safety and avoid property damage, you must pay attention to the warning symbols and tips in the manual.





Warning symbol	Name	Description
	Danger	Severe personal injury or even death can result if related requirements are not followed.
	Warning	Personal injury or equipment damage can result if related requirements are not followed.





1.3 Personnel requirements

Trained and qualified professionals: People operating the equipment must have received professional electrical and safety training and obtained the certificates, and must be familiar with all steps and requirements of equipment installing, commissioning, running and maintaining and capable to prevent any emergencies.

1.4 Safety guidelines

General principles	
	<ul style="list-style-type: none"> • Only trained and qualified professionals are allowed to perform related operations. • Do not perform wiring, inspection or component replacement when power supply is applied. Ensure that all the input power supplies are disconnected before wiring and inspection. • The product design is applied to indoor electrical environments at overvoltage category II. Ensure that the product power supply system has surge protection devices to prevent lightning overvoltage from being applied to the power input or signal I/O terminals of the product so as to avoid equipment damage. • Do not modify the product unless authorized; otherwise fire, electric shock or other injury may result. • Prevent cables and other conductive parts from falling into the product. • Do not contact the product with damp objects or body parts. Otherwise, electric shock may result.

Delivery	
	<ul style="list-style-type: none"> • Select appropriate tools for product delivery, and take mechanical protective measures like wearing safety shoes and working uniforms to avoid personal injury. • Protect the product against physical shock or vibration.
Installation	
	<ul style="list-style-type: none"> • Do not install the product on inflammables. In addition, prevent the product from contacting or adhering to inflammables. • Do not run a damaged or incomplete product.
	<ul style="list-style-type: none"> • Install the product in a lockable control cabinet of at least IP20, which prevents the personnel without electrical equipment related knowledge from touching by mistake, since the mistake may result in equipment damage or electric shock. Only personnel who have received related electrical knowledge and equipment operation training can operate the control cabinet. • During installation, ensure that the modules are tightly connected and fastened. Insecure connection may cause problems such as communication failure and fall-off. • After installation, ensure that there are no obstructions on the vents of the product; otherwise, the chips of the product may be burned due to overheating and poor heat dissipation, which causes system control failure and misoperation.
Wiring	
	<ul style="list-style-type: none"> • Before wiring, clearly understand the necessary information including interfaces, power supply types, and specifications, and comply with relevant standards and requirements to ensure that the system wiring is correct. • To ensure personal safety and equipment use safety, reliably ground the product using cables with proper diameters and specifications. • Route the control signal and communication signal cables separately from cables with strong interference such as power cables. • Apply fastening means to long-distance or heavy cables.
	<ul style="list-style-type: none"> • Cut off all power supplies connected to the product before performing wiring. • Before power-on for running, ensure that each module terminal cover is properly installed in place after the installation and wiring are completed. This prevents a live terminal from being touched. Otherwise, physical injury, equipment fault or misoperation may result. • Install proper protection components or devices when using external power supplies for the product. This prevents the product from being damaged due to external power supply faults, overvoltage, overcurrent, or other exceptions.

Commissioning and running	
	<ul style="list-style-type: none"> • Before power-on for running, ensure that the working environment of the product meets the requirements (see 4.1.2 Installation environment and site for details), and a protection circuit has been designed to protect the product so that the product can run safely even if an external device fault occurs. • When the output units such as relays and transistors of the product are damaged, the output cannot be controlled to be On or Off as configured. • For modules or terminals requiring external power supply, configure external safety devices such as fuses or circuit breakers to prevent damage caused due to external power supply or device faults. • In the external circuit of the product, configure an emergency braking circuit, a protection circuit, a circuit for interlocking between forward and reverse operations, and an anti-equipment-damage switch for interlocking between the position upper limit and lower limit. • To ensure the safe running of equipment, design external protection circuits and safety mechanisms for output signals related to major accidents. • Design proper external control circuits to ensure the proper running of equipment, since outputs may be out of control when the control circuit has an exception.
Maintenance and component replacement	
	<ul style="list-style-type: none"> • Keep the product and its parts and components away from combustible materials and ensure they have no combustible materials adhered. • Before carrying out product maintenance or component operations, cut off all power supplies connected to the product. • Prevent the screws, cables and other conductive parts from falling into the product during maintenance or component replacement. • During maintenance and component replacement, take proper anti-static measures on the product and its internal parts.
Note	<ul style="list-style-type: none"> • Use proper torque to tighten screws.
Disposal	
	<ul style="list-style-type: none"> • The product contains heavy metals. Dispose of a scrap product as industrial waste.
	<ul style="list-style-type: none"> • Dispose of a scrap product separately at an appropriate collection point but not place it in the normal waste stream.

2 Communication coupler specifications

2.1 EtherCAT communication coupler

2.1.1 FK1100

2.1.1.1 Basic information

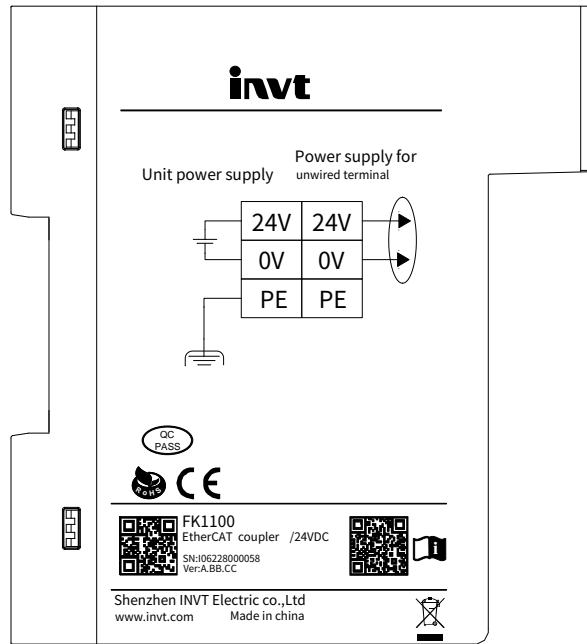

Model	Ordering No.	Description	Applicable model
FK1100	11016-00005	Communication coupler, EtherCAT, 24VDC; RoHS	Applicable to INVT and third-party EtherCAT master devices

2.1.1.2 Component description

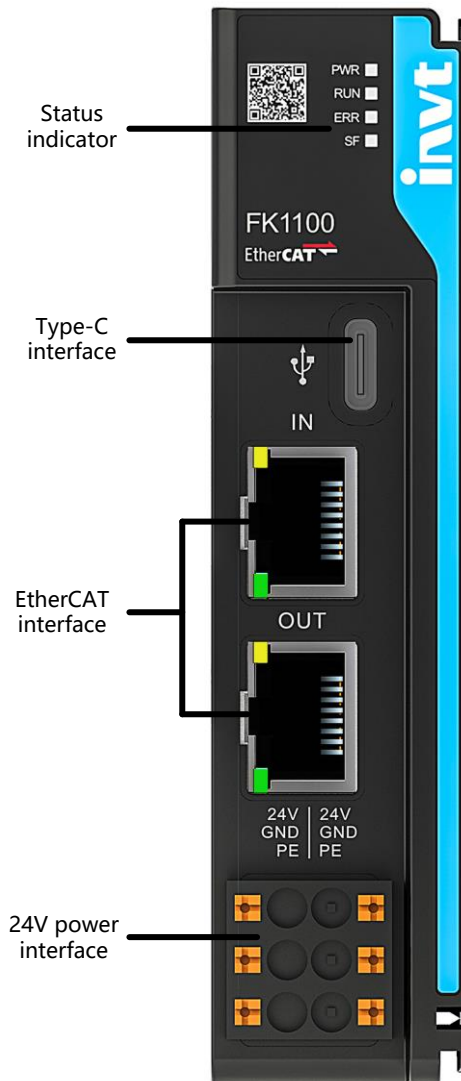

Interface	Definition		
Status indicator	PWR: Power indicator (Green)	On	The power connection is normal.
		Off	The power connection is abnormal.
	RUN: Run indicator (Green)	Off	The communication coupler module is in INIT state.
		Blinking	The communication coupler module is Pre-Operational state.
		Single flash	The communication coupler module is in Safe-Operational state.
	ERR: Fault indicator (Red)	On	The communication coupler module is Operational state.
		Off	The EtherCAT communication is in normal state.
		Blinking	A status conversion command that cannot be executed has been received through the EtherCAT communication.
		Single flash	The network is disconnected, and the communication coupler module encounters a synchronization error.
		Double	A Watchdog error occurs to the EtherCAT

Interface	Definition		
SF: Fieldbus fault indicator (Red)	flash	communication.	
	Off	The equipment running is normal.	
	Blinking	Configuration error occurs.	
	On	A communication coupler FPGA fault occurs.	
USB type-C interface	Used for single board software upgrade		
EtherCAT interface	IN: EtherCAT input port		
	OUT: EtherCAT output port		
24V power interface	24VDC power input interface of module		

2.1.1.3 Hardware specifications

Item	Specifications
Rated input voltage	24VDC (20.4VDC–28.8VDC)
Rated input current	0.8A (Typical value at 24VDC)
Backplane fieldbus output rated voltage	5VDC (4.75VDC–5.25VDC)
Backplane fieldbus output rated current	2.5A (Typical value at 5VDC)
Isolation	The input power is not isolated.
Power supply protection	Protection against overcurrent, reverse connection, and surges

2.1.1.4 Software specifications

Item	Specifications
Alias access	Supporting EtherCAT alias access and site alias setup on backend. Alias range: 1–65535 ✍ Note: The expansion modules connected behind the EtherCAT communication coupler do not support alias access or setup.
Quantity of input PDO	Up to 768 bytes
Quantity of output PDO	Up to 768 bytes
Input mailbox size	Up to 128 bytes
Output mailbox size	Up to 128 bytes

2.1.1.5 Environment requirements

Item	Specifications
Working environment temperature	-20°C–55°C
Working environment relative humidity (RH)	RH < 95%, no condensation
Storage temperature	-40°C– 70°C (RH < 90%, no condensation)
Air	No corrosive gas
Altitude	Lower than 3000m
Pollution degree	Below degree 2

Item	Specifications
Immunity	2kV power cable compliant with IEC61000-4-4
Overvoltage category	Category II
EMC anti-interference level	Zone B, compliant with IEC61131-2
vibration resistance	Compliant with IEC 60068-2-6
Impact resistance	Compliant with IEC 60068-2-27

2.2 PROFINET communication coupler

2.2.1 FK1200

2.2.1.1 Basic information

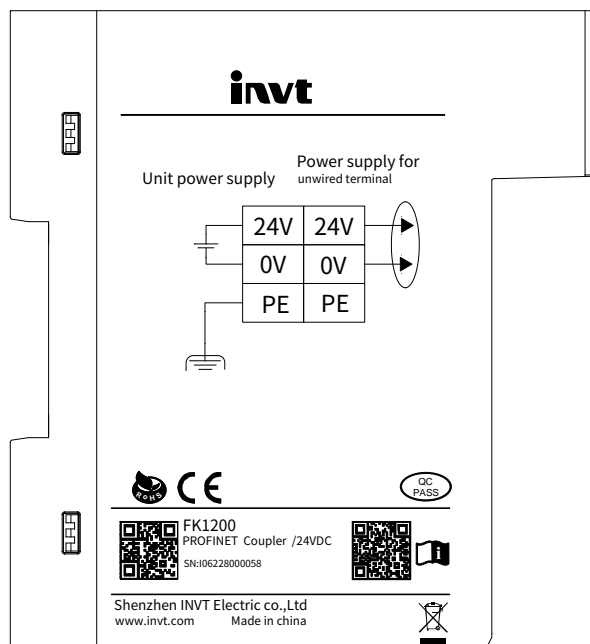

Model	Ordering No.	Description	Applicable model
FK1200	11016-00012	Communication coupler, PROFINET, 24VDC; RoHS	Applicable to PROFINET master devices

2.2.1.2 Component description

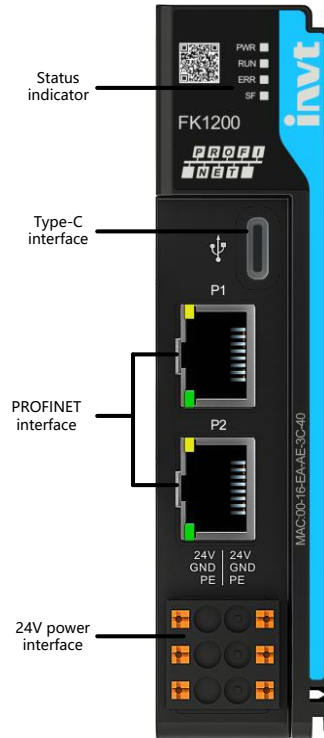

Interface	Definition		
Status indicator	PWR: Power indicator (Green)	On	The power connection is normal.
		Off	The power connection is abnormal.
	RUN: Run indicator (Green)	Off	Initial state
		Fast blinking	Waiting for connection/Connecting.
		Slow blinking	Safe mode
	ERR: Fault indicator (Red)	On	The communication is normal.
		Off	In normal state
		Fast blinking	A communication fault occurred.
	SF: Fieldbus fault indicator (Red)	Slow blinking	An expansion module fault occurred.
		Off	The equipment running is normal.
Blinking		Configuration inconsistency.	
On	An extended function fault occurred.		
USB type-C interface	Used for single board software upgrade		
PROFINET interface	P1: PROFINET interface 1		
	P2: PROFINET interface 2		
24V power interface	24VDC power input interface of module		

2.2.1.3 Hardware specifications

Item	Specifications
Rated input voltage	24VDC (20.4VDC–28.8VDC)
Rated input current	0.8A (Typical value at 24VDC)
Backplane fieldbus output rated voltage	5VDC (4.75VDC–5.25VDC)
Backplane fieldbus output rated current	2.5A (Typical value at 5VDC)
Isolation	The input power is not isolated.
Power supply protection	Protection against overcurrent, reverse connection, and surges

2.2.1.4 Software specifications

Item	Specifications
Communication mode	RT mode
Min. communication period	1ms
I&M data	From I&M0 to I&M3
PROFINET version	V2.43
Expansion capability	Supporting 16 modules
PROFINET interface quantity	2
PROFINET switch function	Supporting the function of networking
Supported open IE	TCP/IP, SNMP, and LLDP
Alarm/Diagnosis/Status information	Supported. Function codes can be uploaded from the local to the PLC.
Physical layer	100BASE-TX
Communication rate	10M bit/s (for standard Ethernet); 100M bit/s (for PROFINET)
Communication method	Full duplex
Topology structure	Linear, star, or tree topology
Transmission medium	Category-5 or higher network cables
Transmission distance	Less than 100m between two nodes
Startup with priority	Reserved
Port disabling	Not supported
Supporting device replacement without configuration	Supported (PN module of the same type)
Restoring factory settings	Supported

2.2.1.5 Environmental requirements

Item	Specifications
Working environment temperature	-20°C–55°C
Working environment	RH < 95%, no condensation

Item	Specifications
relative humidity (RH)	
Storage temperature	-40°C– 70°C (RH < 90%, no condensation)
Air	No corrosive gas
Altitude	Lower than 3000m
Pollution degree	Below degree 2
Immunity	2kV power cable compliant with IEC61000-4-4
Overvoltage category	Category II
EMC anti-interference level	Zone B, compliant with IEC61131-2
vibration resistance	Compliant with IEC 60068-2-6
Impact resistance	Compliant with IEC 60068-2-27

3 I/O module specifications

3.1 Digital input module

3.1.1 FL1001 (1600D)

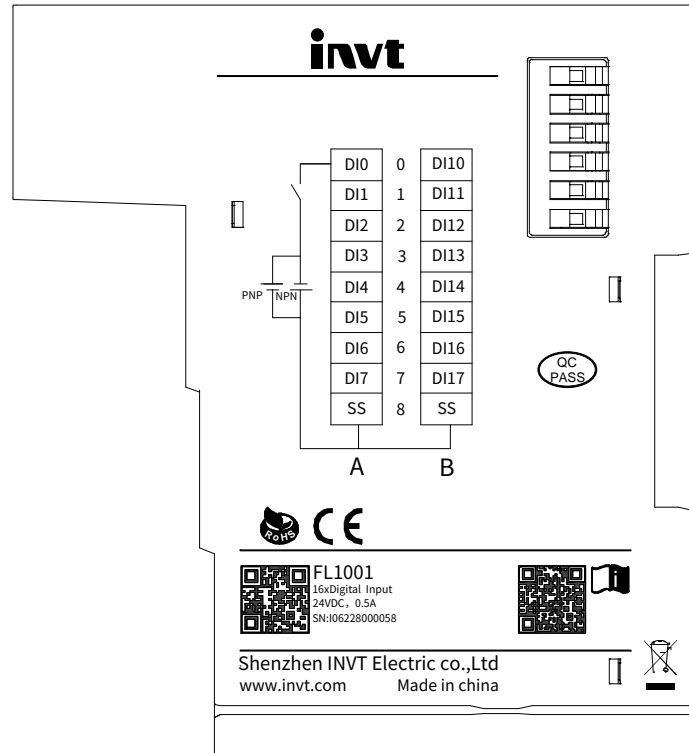

3.1.1.1 Basic information



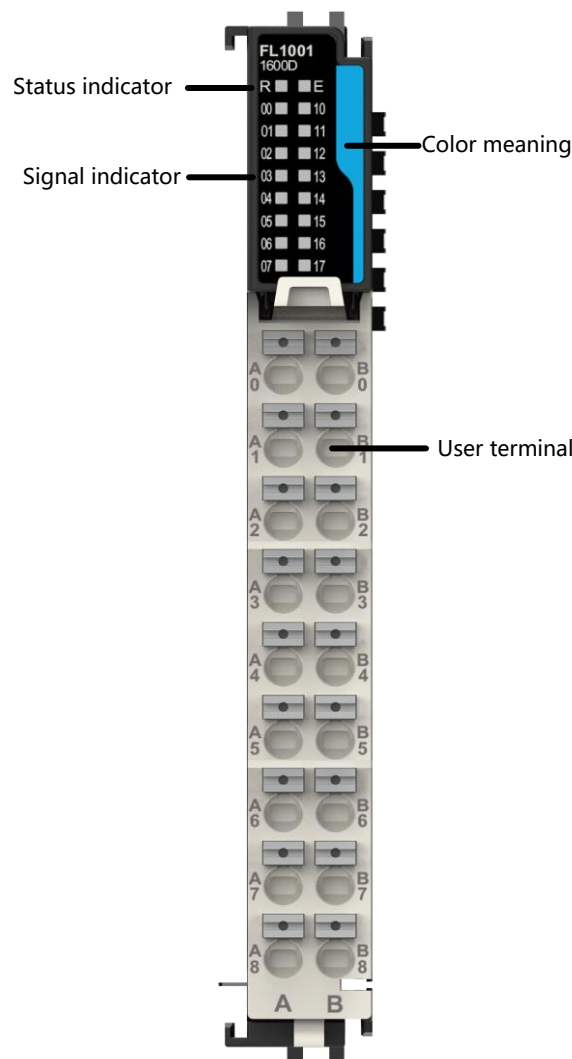

Model	Ordering No.	Description	Applicable model
FL1001	11016-00004	Digital input module, 16 channels, supporting the source and sink types, 500mA@ 24 VDC inputs; RoHS	Applicable to INVT Flex/TS/TM series

3.1.1.2 Component description



Name	Description		
Status indicator	R: Yellow green	Power-on/Run indicator	status
			On: The module is running. Slow flashing (2.5Hz): The module is establishing communication. Off: The module is not powered on or it is abnormal.
	E: Red	Module fault indicator	Off: The module works normally. Slow flashing (2.5Hz): Incorrect parameter settings. Fast flashing (10Hz): The module is offline.
Signal indicator	00–07: Green 10–17: Green	Each corresponds to a channel of input signal.	On: The input is valid. Off: The input is invalid.
User terminal	External wiring I/O terminal		
Color meaning	 Digital input	 Digital output (source, sink, relay)	

Name	Description	
	 Analog input (voltage, current, thermocouple)	 Analog output

3.1.1.3 Power supply specifications

Item	Specifications
Fieldbus input power rated voltage	5VDC (4.75VDC–5.25VDC)
Fieldbus input power rated current	150mA (Typical value at 5VDC)
Terminal input power rated voltage	None
Terminal input power rated current	None
Terminal output power rated voltage	None
Terminal output power rated current	None
Hot swapping of module	Not supported

3.1.1.4 Input specifications

Item	Specifications
Input type	Digital input
Input mode	Source/Sink
Input channel	16
Input voltage class	24VDC±10% (21.6VDC–26.4VDC)
Input current (Typical)	7mA (Typical value at 24VDC)
ON voltage	>15V
OFF voltage	<5V
Hardware response time ON/OFF	100µs/100µs
Software filter time	Supported
Input resistance	Reference value about 3.4KΩ
Isolation	Optocoupler
Input action display	When the input is in driving state, the input indicator is on.
Input derating	Derate by 75% when operating at 55°C (with no more than 12 input points that are on at the same time), or by 10°C when all input points are on

3.1.1.5 Software specifications

Item	Specifications
Software input filter time	Setting range: 1–65535 (default: 1000); unit: 10µs; 1000 indicates 10ms. Able to set two groups of filter parameter. Every eight channels use a group of filter parameter.
Input port exception detection and	None

Item	Specifications
indication	
Input channel logic level configuration	Not supported
Configuration of independent channel enabling	Not supported
Configuration of diagnosis reporting	Diagnosis information will be uploaded by default.
In stop mode	Output will not be refreshed, while input supports refreshing in Safe-operational state.
I/O mapping	Supporting the mapping method of bitwise access

3.1.1.6 Environment requirements

Item	Specifications
Working environment temperature	-20°C–55°C
Working environment relative humidity (RH)	RH < 95%, no condensation
Storage temperature	-40°C–70°C (RH < 90%, no condensation)
Air	No corrosive gas
Altitude	Lower than 3000m
Pollution degree	Below degree 2
Immunity	2kV power cable compliant with IEC61000-4-4
Overvoltage category	Category II
EMC anti-interference level	Zone B, compliant with IEC61131-2
vibration resistance	Compliant with IEC 60068-2-6
Impact resistance	Compliant with IEC 60068-2-27

3.2 Digital output module (Source type)

3.2.1 FL2002 (0016DP)

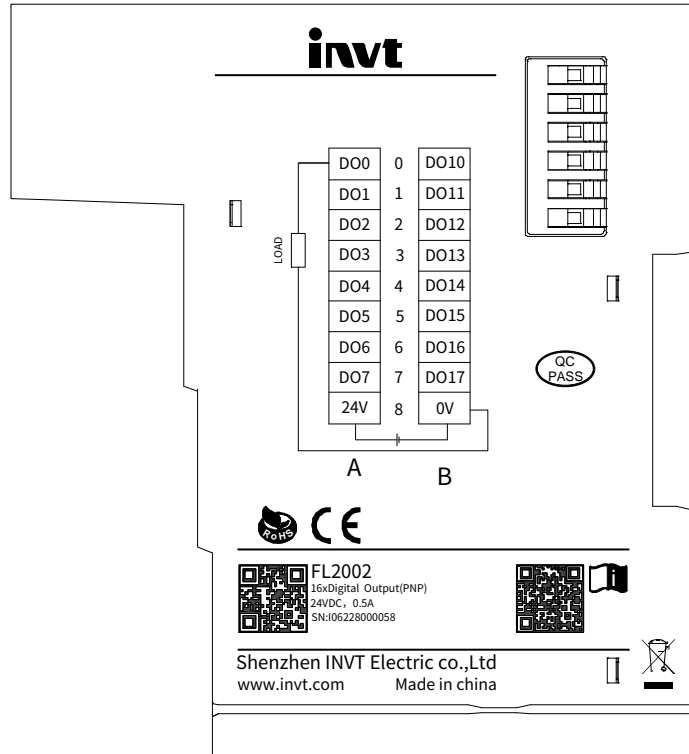

3.2.1.1 Basic information



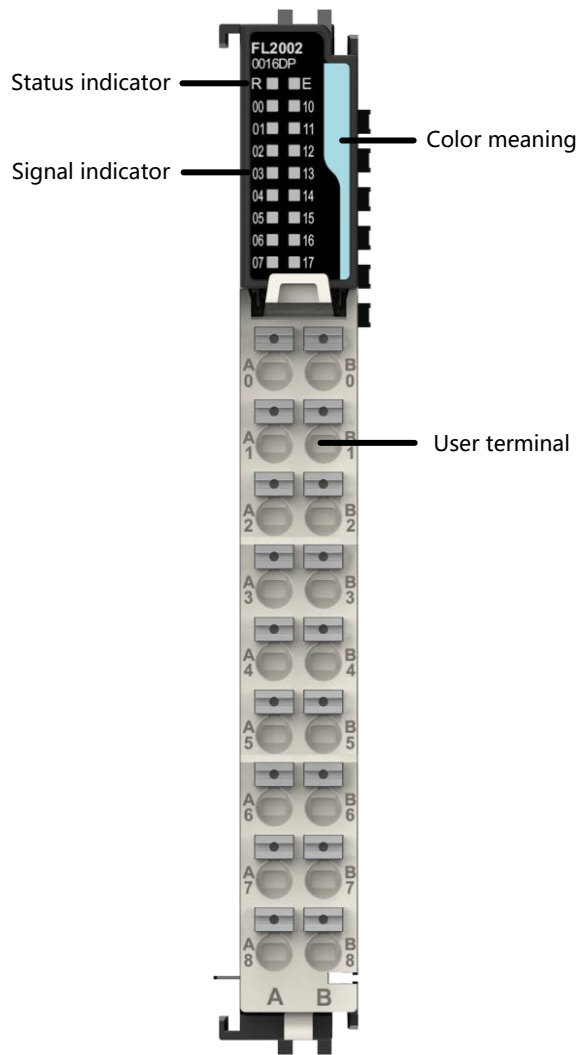

Model	Ordering No.	Description	Applicable model
FL2002	11016-00006	Digital output module, with 16 channels of PNP transistor output, 500mA @ 24 VDC; RoHS	Applicable to INVT Flex/TS/TM series

3.2.1.2 Component description



Name		Description	
Status indicator	R: Yellow green	Power-on/Run indicator	On: The module is running.
			Slow flashing (2.5Hz): The module is establishing communication.
	E: Red	Module fault indicator	Off: The module is not powered on or it is abnormal.
			Off: The module works normally.
Signal indicator	00–07: Green 10–17: Green	Each corresponds to a channel of output signal.	Fast blinking (10Hz): The module is offline.
			Slow flashing (2.5Hz): No power connected externally or incorrect parameter settings.
User terminal	External wiring I/O terminal		
Color meaning	 Digital input	 Digital output (source, sink, relay)	

Name	Description	
	 Analog input (voltage, current, thermocouple)	 Analog output

3.2.1.3 Power supply specifications

Item	Specifications
Fieldbus input power rated voltage	5VDC (4.75VDC–5.25VDC)
Fieldbus input power rated current	150mA
Terminal input power rated voltage	24VDC (20.4VDC–28.8VDC)
Terminal input power rated current	2A (Typical value at 24VDC)
Terminal output power rated voltage	None
Terminal output power rated current	None
Hot swapping of module	Not supported

3.2.1.4 Output specifications

Item	Specifications
Output type	Digital output, high-edge output
Output mode	Source type
Output channel	16
Output voltage class	24VDC±10% (21.6VDC–26.4VDC)
Output load (Resistance load)	0.5A/point, 2A/module
Output load (Inductance load)	7.2W/point, 12W/module
Output load (Light load)	5W/point, 18W/module
Hardware response time ON/OFF	100µs/100µs
Leakage current at OFF	10µA
Switch frequency	100Hz for resistance load, 0.5Hz for resistance load, and 10Hz for light load
Isolation	Yes
Output action display	When the output is in driving state, the output indicator is on.
Input derating	None
Protection functions	Short-circuit protection and overcurrent protection

3.2.1.5 Software specifications

Item	Specifications
Stop/offline output mode	Keeping output, clearing output, or outputting the preset value, which is configured on a point basis
Preset value of stop/offline output	Single-point 0 or 1
Output channel	None

Item	Specifications
exception detection indication	
Output channel logic level configuration	Not supported
Configuration of independent channel enabling	Not supported
Configuration of diagnosis reporting	Diagnosis information will be uploaded by default.
In stop mode	Output according to the stop/offline output mode and preset value, without refreshing any more
IO mapping	Supporting the mapping method of bitwise access

3.2.1.6 Environment requirements

Item	Specifications
Working environment temperature	-20°C–55°C
Working environment relative humidity (RH)	RH < 95%, no condensation
Storage temperature	-40°C–70°C (RH < 90%, no condensation)
Air	No corrosive gas
Altitude	Lower than 3000m
Pollution degree	Below degree 2
Immunity	2kV power cable compliant with IEC61000-4-4
Overvoltage category	Category II
EMC anti-interference level	Zone B, compliant with IEC61131-2
vibration resistance	Compliant with IEC 60068-2-6
Impact resistance	Compliant with IEC 60068-2-27

3.3 Digital output module (Sink type)

3.3.1 FL2102 (0016DN)

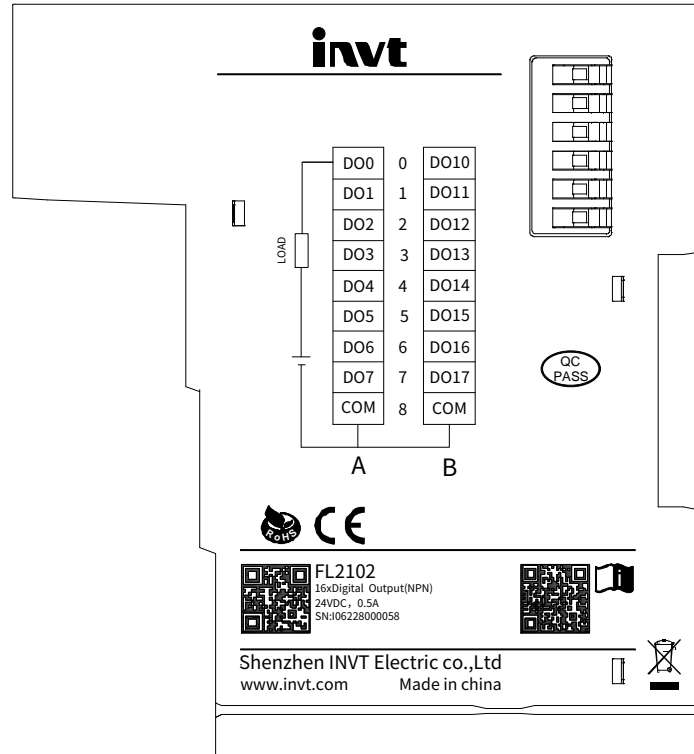

3.3.1.1 Basic information



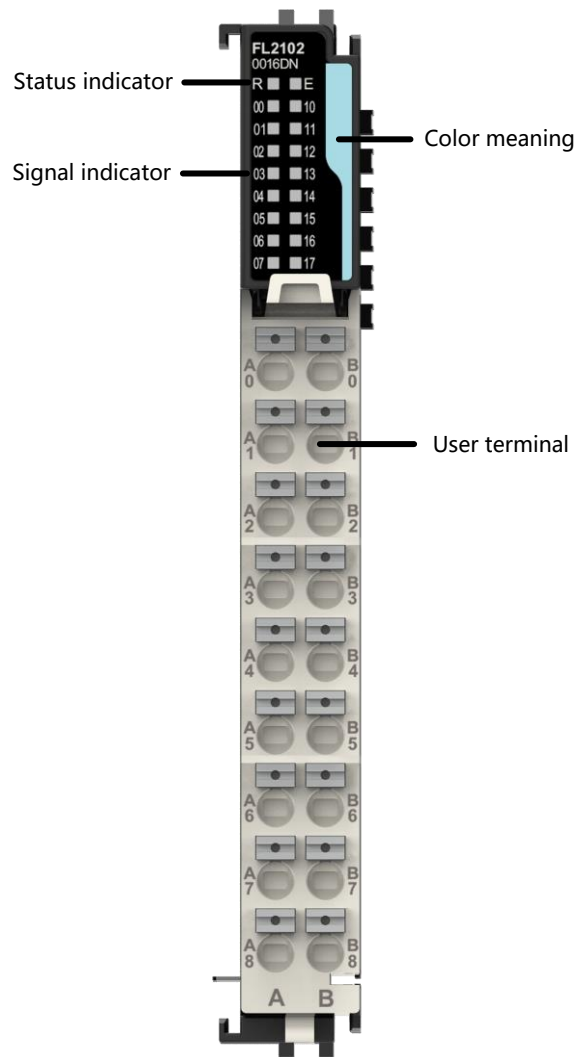

Model	Ordering No.	Description	Applicable model
FL2102	11016-00003	Digital output module, with 16 channels of NPN transistor output, 500mA @ 24 VDC; RoHS	Applicable to INVT Flex/TS/TM series

3.3.1.2 Component description



Name		Description	
Status indicator	R: Yellow green	Power-on/Run status indicator	On: The module is running.
			Slow flashing (2.5Hz): The module is establishing communication.
	E: Red	Module fault indicator	Off: The module is not powered on or it is abnormal.
			Off: The module works normally.
Signal indicator	00–07: Green 10–17: Green	Each corresponds to a channel of output signal.	Fast blinking (10Hz): The module is offline.
			Slow flashing (2.5Hz): Channel overheat/overcurrent alarm or incorrect parameter settings.
User terminal	External wiring I/O terminal		
Color meaning	 Digital input	 Digital output (source, sink, relay)	

Name	Description	
	 Analog input (voltage, current, thermocouple)	 Analog output

3.3.1.3 Power supply specifications

Item	Specifications
Fieldbus input power rated voltage	5VDC (4.75VDC–5.25VDC)
Fieldbus input power rated current	200mA
Terminal input power rated voltage	None
Terminal input power rated current	None
Terminal output power rated voltage	None
Terminal output power rated current	None
Hot swapping of module	Not supported

3.3.1.4 Output specifications

Item	Specifications
Output type	Digital output, low-edge output
Output mode	Sink
Output channel	16
Output voltage class	24VDC±10% (21.6VDC–26.4VDC)
Output load (Resistance load)	0.5A/point, 4A/module
Output load (Inductance load)	7.2W/point, 24W/module
Output load (Light load)	5W/point, 18W/module
Hardware response time ON/OFF	100µs/100µs
Leakage current at OFF	10µA
Switch frequency	100Hz for resistance load, 0.5Hz for resistance load, and 10Hz for light load
Isolation	Yes
Output action display	When the output is in driving state, the output indicator is on.
Input derating	None
Protection functions	Short-circuit protection and overcurrent protection

3.3.1.5 Software specifications

Item	Specifications
Stop/offline output mode	Keeping output, clearing output, or outputting the preset value, which is configured on a point basis
Preset value of stop/offline output	Single-point 0 or 1

Item	Specifications
Output channel exception detection indication	Overheat/overcurrent detection and protection on a module basis
Output channel logic level configuration	Not supported
Configuration of independent channel enabling	Not supported
Configuration of diagnosis reporting	Diagnosis information will be uploaded by default.
In stop mode	Output according to the stop/offline output mode and preset value, without refreshing any more
IO mapping	Supporting the mapping method of bitwise access

3.3.1.6 Environment requirements

Item	Specifications
Working environment temperature	-20°C–55°C
Working environment relative humidity (RH)	RH < 95%, no condensation
Storage temperature	-40°C–70°C (RH < 90%, no condensation)
Air	No corrosive gas
Altitude	Lower than 3000m
Pollution degree	Below degree 2
Immunity	2kV power cable compliant with IEC61000-4-4
Overvoltage category	Category II
EMC anti-interference level	Zone B, compliant with IEC61131-2
vibration resistance	Compliant with IEC 60068-2-6
Impact resistance	Compliant with IEC 60068-2-27

3.4 Digital output module (Relay)

3.4.1 FL2201 (0008DR)



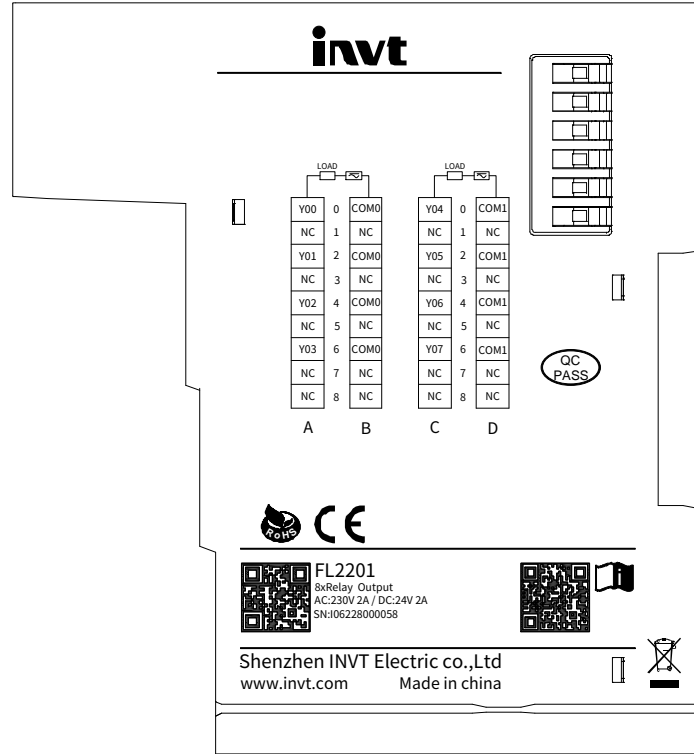

3.4.1.1 Basic information

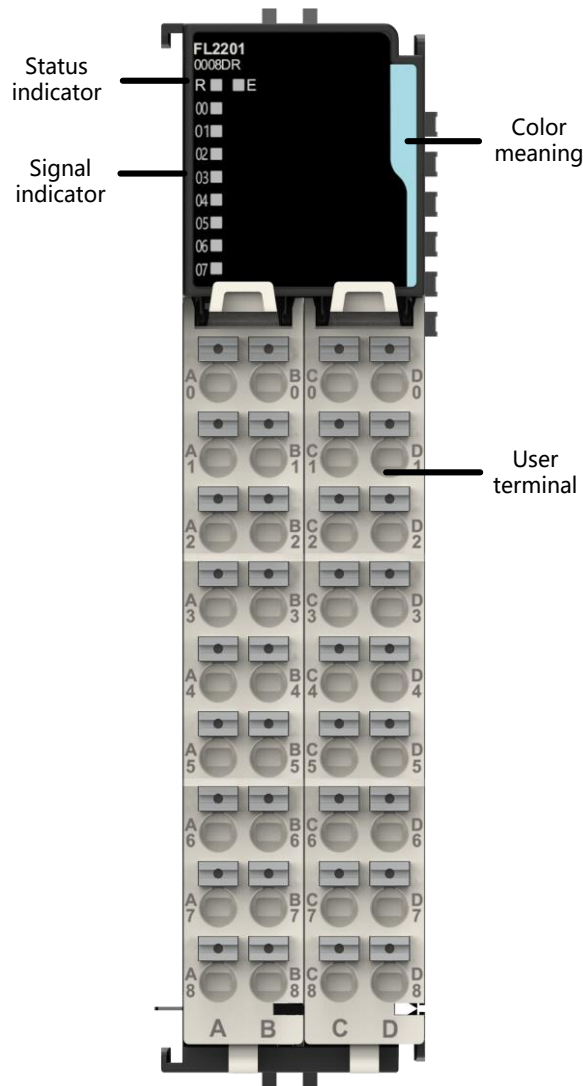

Model	Ordering No.	Description	Applicable model
FL2201	11016-00009	Digital output, 8 relay outputs, dry contacts,3A@30VDC/250VAC;RoHS	Applicable to INVT Flex/TS/TM series

3.4.1.2 Component description



Name	Description		
Status indicator	R: Yellow green	Power-on/Run indicator	status
			On: The module is running.
	E: Red	Module fault indicator	status
			Slow flashing (2.5Hz): The module is establishing communication.
Signal indicator	00–07: Green	Each corresponds to a channel of output signal.	On: Enable output.
			Off: Disable output.
User terminal	External wiring I/O terminal		
Color meaning	 Digital input	 Digital output (source, sink, relay)	
	 Analog input (voltage, current, thermocouple)	 Analog output	

3.4.1.3 Power supply specifications

Item	Specifications
Fieldbus input power rated voltage	5VDC (4.75VDC–5.25VDC)
Fieldbus input power rated current	300mA
Terminal input power rated voltage	None
Terminal input power rated current	None
Terminal output power rated voltage	None
Terminal output power rated current	None
Hot swapping of module	Not supported

3.4.1.4 Output specifications

Item	Specifications
Output mode	Relay N.O.
Output channel	8
Contact load (Resistance load)	3A 250VAC/30VDC
Max. switching voltage	250VAC/125VDC (@0.3A)
Max. switching current	3A
Contact resistor	<100mΩ (1A 6VDC)
Minimum load	5VDC 10mA
Isolation	Strong current isolated from weak current

3.4.1.5 Software specifications

Item	Specifications
Stop/offline output mode	Keeping output, clearing output, or outputting the preset value, which is configured on a point basis
Preset value of stop/offline output	Single-point 0 or 1
Output channel exception detection indication	Not supported
Output channel logic level configuration	Not supported
Configuration of independent channel enabling	Not supported
Configuration of diagnosis reporting	Not supported
In stop mode	Output according to the stop/offline output mode and preset value, without refreshing any more
IO mapping	Supporting the mapping method of bitwise access

3.4.1.6 Environment requirements

Item	Specifications
Working environment temperature	-20°C–55°C
Working environment relative humidity (RH)	RH < 95%, no condensation
Storage temperature	-40°C–70°C (RH < 90%, no condensation)
Air	No corrosive gas
Altitude	Lower than 3000m
Pollution degree	Below degree 2
Immunity	2kV power cable compliant with IEC61000-4-4
Overvoltage category	Category II
EMC anti-interference level	Zone B, compliant with IEC61131-2
vibration resistance	Compliant with IEC 60068-2-6
Impact resistance	Compliant with IEC 60068-2-27

3.5 Analog input module

3.5.1 FL3003 (4AD)

3.5.1.1 Basic product information

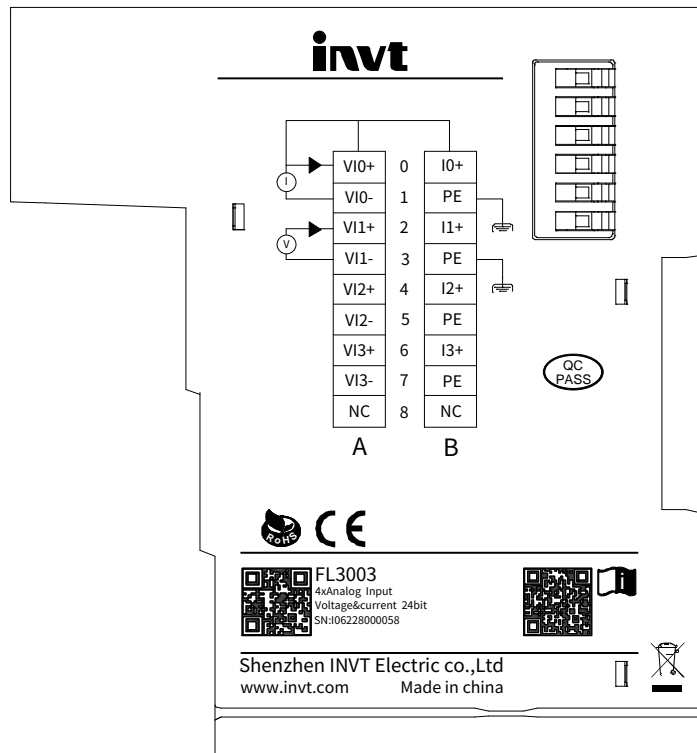



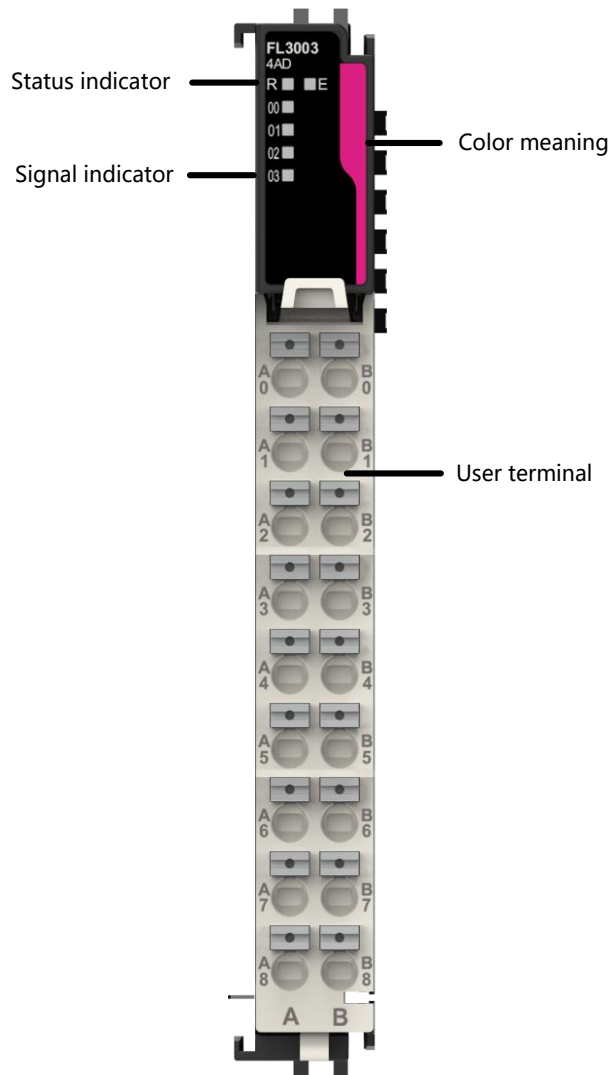

Model	Ordering No.	Description	Applicable model
FL3003	11016-00011	Analog input, 4 channels, 16-bit resolution, room-temperature accuracy of±0.1%FS; RoHS	Applicable to INVT Flex/TS/TM series

3.5.1.2 Component description



Name		Description	
Status indicator	R: Yellow green	Power-on/Run indicator	status
			On: The module is running.
	E: Red	Module fault indicator	Slow flashing (2.5Hz): The module is establishing communication.
			Off: The module is not powered on or it is abnormal.
Signal indicator	00–03: Green	Channel status indicator	Off: The module works normally.
			Fast blinking (10Hz): The module is offline.
			Slow blinking (2.5Hz): ADC chip fault or incorrect parameter settings.
			On: The channel is enabled.
User terminal			Slow blinking (2.5Hz): Input signal
			Incorrect parameter settings.
			Fast blinking (10Hz): Offline at the voltage mode.
			Off: The channel is disabled.
External wiring I/O terminal			

Name	Description	
Color meaning	 Digital input	 Digital output (source, sink, relay)
	 Analog input (voltage, current, thermocouple)	 Analog output

3.5.1.3 Power supply specifications

Item	Specifications
Fieldbus input power rated voltage	5VDC (4.75VDC–5.25VDC)
Fieldbus input power rated current	200mA
Terminal input power rated voltage	None
Terminal input power rated current	None
Terminal output power rated voltage	None
Terminal output power rated current	None
Hot swapping of module	Not supported

3.5.1.4 Input specifications

Item	Specifications
Input type	Analog input
Input mode	Voltage/current
Input channel	4
Resolution	16 bits
Conversion time	320µs/channel
Voltage input range	0–5V, 0–10V, -5–+5V, -10–+10V
Voltage input resistance	2.4MΩ
Voltage input accuracy (25°C)	±0.1%
Voltage input accuracy (in full temperature range)	±0.2%
Voltage input limit	± 12V
Voltage input diagnosis	Disconnection detection supported
Current input range	±20mA, 0–20mA, 4–20mA
Current input resistance	240Ω
Current input accuracy (at 25°C)	±0.1%
Current input accuracy (in full temperature range)	±0.2%
Current input limit	± 24mA
Current input diagnosis	Not supported
Isolation	No isolation between interface channels; voltage isolated from

Item	Specifications
	interface; interface isolated from bus
Input action display	None
Input derating	None

3.5.1.5 Software specifications

Item	Specifications
Configuration of independent channel enabling	Supported
Configuration of diagnosis reporting	Supported
Configuration of enabling diagnosis detection	Voltage-side disconnection, over-range detection, and over-limit detection
Mode switchover configuration	0–5V, 0–10V, ±5V, ±10V, 4–20mA, 0–20mA, ±20mA
Filter parameter configuration	Software filter time can be set through the upper computer, which ranges from 1 to 255, with the sampling period as the unit.
Configuration of enabling over-limit detection	Supported
Configuration of enabling peak holding	Not supported
Configuration of conversion digital range	±20000
Sampling period	1.28ms for 4 channels
Sampling refresh	Sampling time based asynchronous refresh, but not bus period based synchronous refresh
Stop mode	Present value kept, without refresh

3.5.1.6 Environment requirements

Item	Specifications
Working environment temperature	-20°C–55°C
Working environment relative humidity (RH)	RH < 95%, no condensation
Storage temperature	-40°C–70°C (RH < 90%, no condensation)
Air	No corrosive gas
Altitude	Lower than 3000m
Pollution degree	Below degree 2
Immunity	2kV power cable compliant with IEC61000-4-4
Overvoltage category	Category II
EMC anti-interference level	Zone B, compliant with IEC61131-2
vibration resistance	Compliant with IEC 60068-2-6
Impact resistance	Compliant with IEC 60068-2-27

3.6 Analog output module

3.6.1 FL4003 (4DA)

3.6.1.1 Basic product information

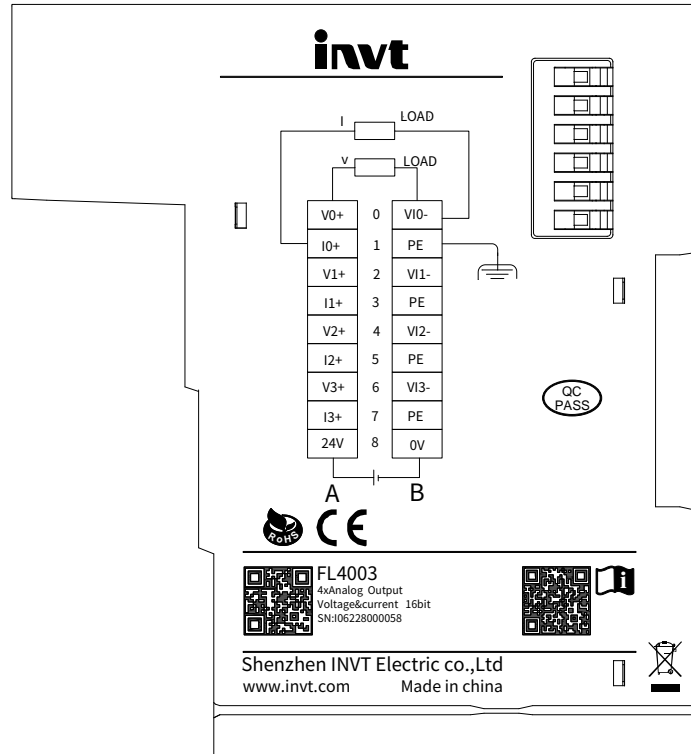



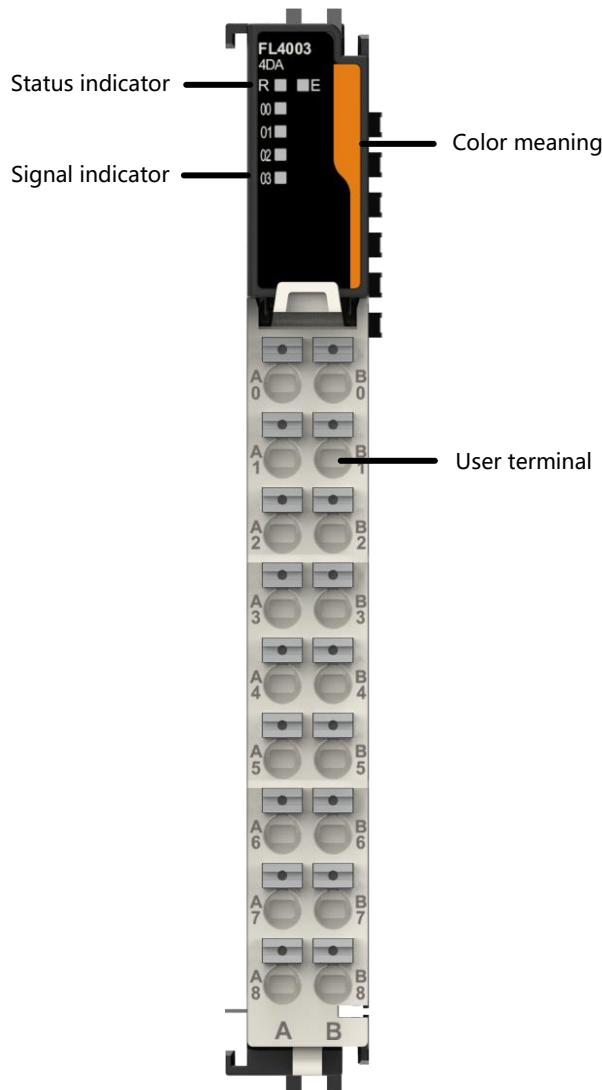

Model	Ordering No.	Description	Applicable model
FL4003	11016-00008	Analog output module, 4 channels, 16-bit resolution, room-temperature accuracy of $\pm 0.1\%$ FS; RoHS	Applicable to INVT Flex/TS/TM series

3.6.1.2 Component description



Name		Description	
Status indicator	R: Yellow green	Power-on/Run status indicator	On: The module is running.
			Slow flashing (2.5Hz): The module is establishing communication.
			Off: The module is not powered on or it is abnormal.
	E: Red	Module fault indicator	Off: The module works normally.
			Fast blinking (10Hz): The module is offline.
			Slow blinking (2.5Hz): DAC chip external power exception or parameter setting error.
	00-03: Green	Channel status indicator	On: The channel is enabled.
			Slow blinking (2.5Hz): Short circuit or incorrect parameter settings.
			Fast blinking (10Hz): Current disconnection.
Off: The channel is disabled.			

Name	Description	
User terminal	External wiring I/O terminal	
Color meaning	 Digital input	 Digital output (source, sink, relay)
	 Analog input (voltage, current, thermocouple)	 Analog output

3.6.1.3 Power supply specifications

Item	Specifications
Fieldbus input power rated voltage	5VDC (4.75VDC–5.25VDC)
Fieldbus input power rated current	150mA
Terminal input power rated voltage	24VDC (20.4VDC–28.8VDC)
Terminal input power rated current	100mA (Typical value at 24VDC)
Terminal output power rated voltage	None
Terminal output power rated current	None
Hot swapping of module	Not supported

3.6.1.4 Output specifications

Item	Specifications
Output type	Analog output
Output mode	Voltage/current
Output channel	4
Resolution	16 bits
Conversion time	40μs/channel
Voltage output range	0–5V, 0–10V, -5–+5V, -10–+10V
Voltage output load	1kΩ
Voltage output accuracy (25°C)	±0.1%
Voltage output accuracy (in full temperature range)	±0.5%
Voltage output diagnosis	Short circuit detection and overtemperature protection supported
Current output range	0–20mA, 4–20mA
Current output load	<600Ω
Current output accuracy (25°C)	±0.1%
Current output accuracy (in full temperature range)	±0.5%
Current output diagnosis	Open circuit detection and overtemperature protection supported
Isolation	No isolation between interface channels; voltage isolated from

Item	Specifications
	interface; interface isolated from bus
Output action display	None
Output derating	None

3.6.1.5 Software specifications

Item	Specifications
Configuration of independent channel enabling	Supported
Configuration of diagnosis reporting	Supported
Configuration of enabling diagnosis detection	Short circuit detection for voltage, and disconnection detection for current
Mode switchover configuration	0–5V, 0–10V, ±5V, ±10V, 4–20mA, 0–20mA
Output status configuration after stop	Clearing, keeping the present output, or outputting the preset value
Preset value of stop/offline output Configuration	Supported
Configuration of conversion digital range	±20000
Sampling period	160μs for 4 channels
Sampling refresh	Sampling time based asynchronous refresh, but not bus period based synchronous refresh
Stop mode	Output according to the fault-caused stop mode or the preset value, without refreshing any more

3.6.1.6 Environment requirements

Item	Specifications
Working environment temperature	-20°C–55°C
Working environment relative humidity (RH)	RH < 95%, no condensation
Storage temperature	-40°C–70°C (RH < 90%, no condensation)
Air	No corrosive gas
Altitude	Lower than 3000m
Pollution degree	Below degree 2
Immunity	2kV power cable compliant with IEC61000-4-4
Overvoltage category	Category II
EMC anti-interference level	Zone B, compliant with IEC61131-2
vibration resistance	Compliant with IEC 60068-2-6
Impact resistance	Compliant with IEC 60068-2-27

3.7 Temperature detection module (Thermal resistor)

3.7.1 FL3103 (4PT)

3.7.1.1 Basic product information

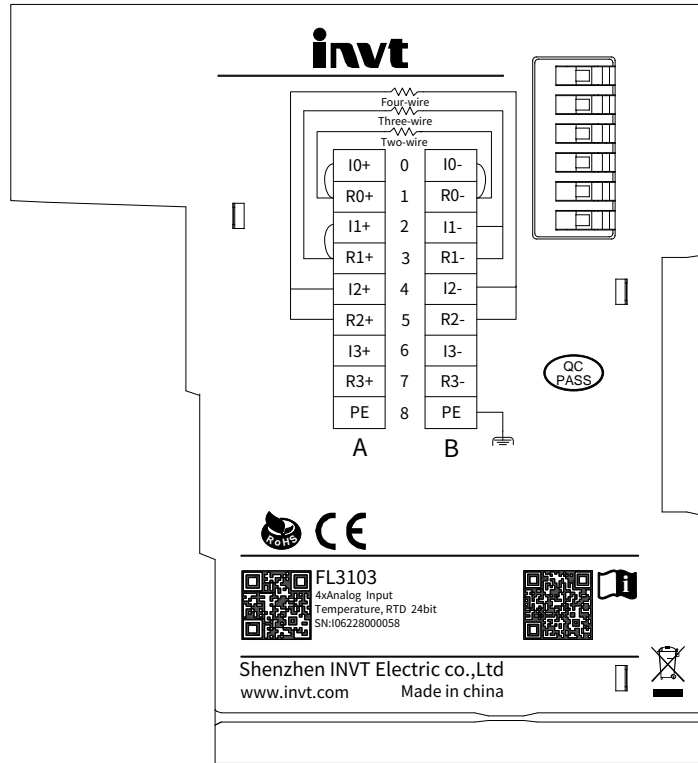



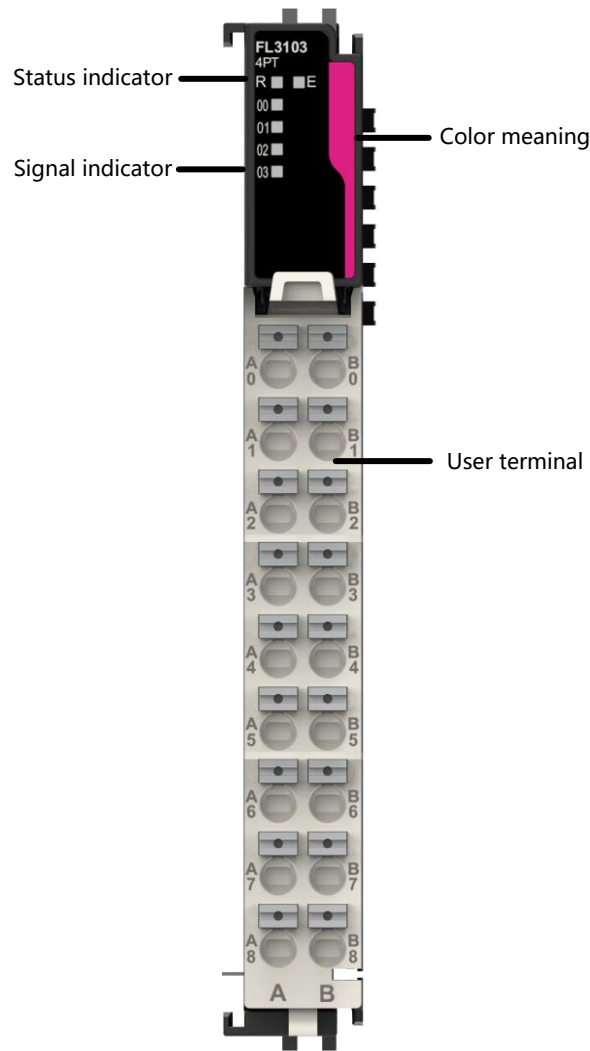

Model	Ordering No.	Description	Applicable model
FL3103	11016-00007	Thermal resistor, 4 channels, 24-bit resolution, sensitivity of 0.1°C/°F; RoHS	Applicable to INVT Flex/TS/TM series

3.7.1.2 Component description



Name	Description		
Status indicator	R: Yellow green	Power-on/Run indicator	status
			On: The module is running.
			Slow flashing (2.5Hz): The module is establishing communication.
	E: Red	Module fault indicator	Off: The module is not powered on or it is abnormal.
			Off: The module works normally.
			Fast blinking (10Hz): The module is offline.
	00–03: Green	Channel status indicator	Slow blinking (2.5Hz): Error in temperature detection.
			On: The channel is enabled.
			Slow blinking (2.5Hz): Input signal out of range or limit.
Fast blinking (10Hz): Disconnection.			
User terminal	Off: The channel is disabled.		
	External wiring I/O terminal		

Name	Description	
Color meaning	 Digital input	 Digital output (source, sink, relay)
	 Analog input (voltage, current, thermocouple)	 Analog output

3.7.1.3 Power supply specifications

Item	Specifications
Fieldbus input power rated voltage	5VDC (4.75VDC–5.25VDC)
Fieldbus input power rated current	250mA
Terminal input power rated voltage	None
Terminal input power rated current	None
Terminal output power rated voltage	None
Terminal output power rated current	None
Hot swapping of module	Not supported

3.7.1.4 Input specifications

Item	Specifications
Input channel	4
Resolution	24 bits
Display sensitivity	0.0625°C, 0.0625°F
Input terminal	Four thermal resistor inputs
Sensor type	Pt100, Pt500, Pt1000, Cu100
Wiring method	Two-wire/Three-wire/Four-wire
Accuracy in room temperature (of 25°C)	Full scale * ± 0.3%
Accuracy (in room temperature -20°C–55°C)	Full scale * ± 1%
Sampling period	Channel 1 and channel 2 form a group, while channel 3 and channel 4 form a group. When both channels within a group are enabled and one channel is configured as a three-wire system, the sampling period is 480ms/channel, and in other cases, the sampling period is 240ms/channel.
Filter parameter	1–255 (Default: 8)
Isolation method	I/O terminals insulated from the power supply; <input checked="" type="checkbox"/> No insulation between channels

3.7.1.5 Software specifications

Item	Specifications
Configuration of	Supported

Item	Specifications
diagnosis reporting	
Configuration of enabling diagnosis detection	Over-limit detection and disconnection detection supported
Configuration of enabling over-limit detection	Supported
Independent channel configuration	Supported
Configuration of enabling temperature offset	Supported
Temperature setting range	-204.8–204.7 temperature unit
Sampling period	Channel 1 and channel 2 form a group, while channel 3 and channel 4 form a group. When both channels within a group are enabled and one channel is configured as a three-wire system, the sampling period is 480ms/channel, and in other cases, the sampling period is 240ms/channel.
Display method	Celsius degree (°C), Fahrenheit degree (°F)
Sensitivity	0.0625°C, 0.0625°F
Sampling refresh	Sampling time based asynchronous refresh, but not bus period based synchronous refresh
Disconnection or over-limit	Output of max. value plus 10°C. Disconnection detection supported.
System diagnosis	Not supported
Channel diagnosis	Upper limit exceeding alarm and lower limit exceeding alarm.
Software diagnosis	Not supported
Configuration diagnosis	Identifying configuration errors, including channel parameter configuration errors.

3.7.1.6 Environment requirements

Item	Specifications
Working environment temperature	-20°C–55°C
Working environment relative humidity (RH)	RH < 95%, no condensation
Storage temperature	-40°C–70°C (RH < 90%, no condensation)
Air	No corrosive gas
Altitude	Lower than 3000m
Pollution degree	Below degree 2
Immunity	2kV power cable compliant with IEC61000-4-4
Overvoltage category	Category II
EMC anti-interference level	Zone B, compliant with IEC61131-2
vibration resistance	Compliant with IEC 60068-2-6
Impact resistance	Compliant with IEC 60068-2-27

3.8 Temperature detection module (Thermocouple)

3.8.1 FL3203 (4TC)

3.8.1.1 Basic product information

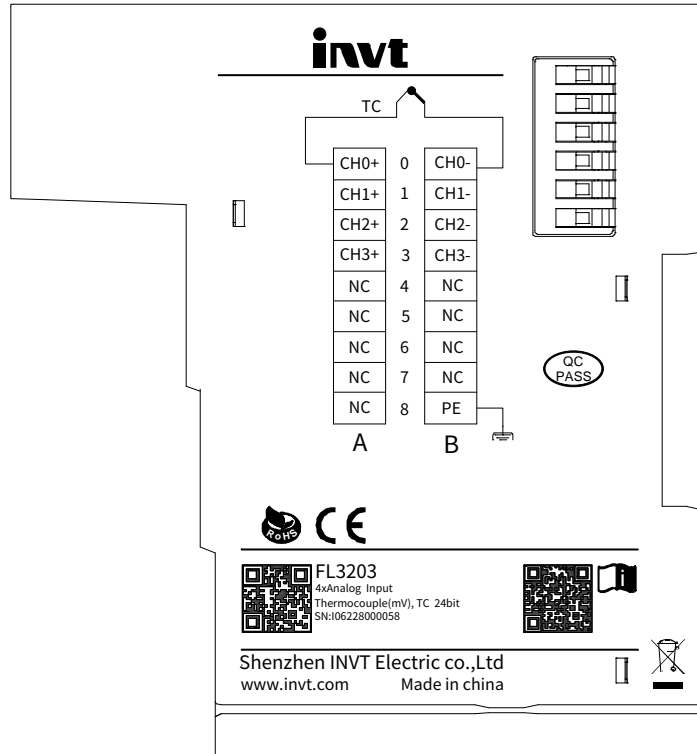



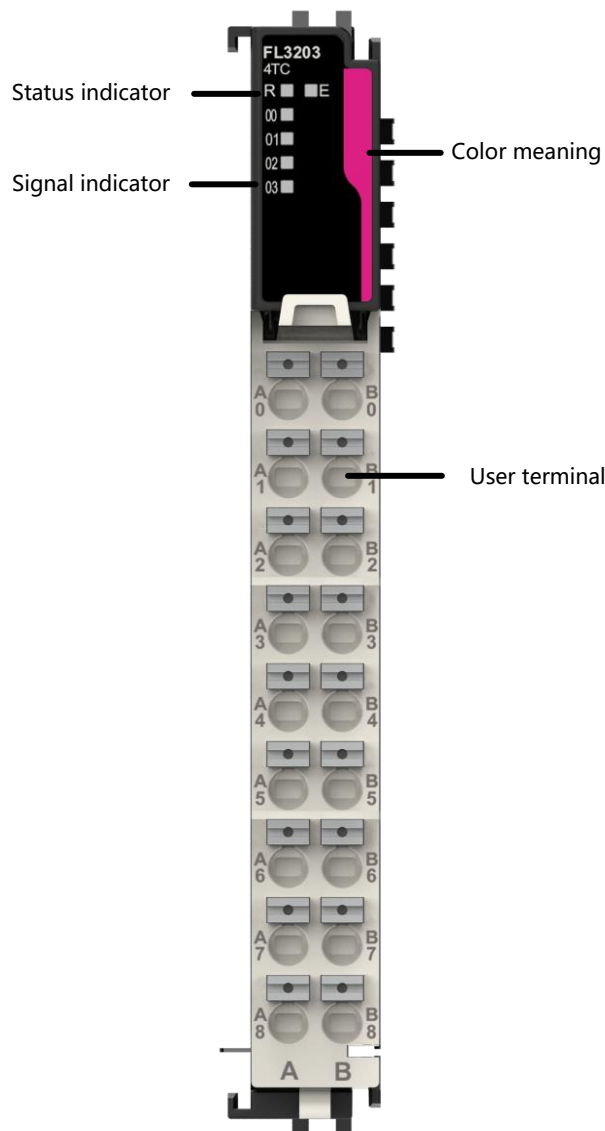

Model	Ordering No.	Description	Applicable model
FL3203	11016-00010	Thermocouple, 4 channels, 24-bit resolution, sensitivity of 0.1°C/°F; RoHS	Applicable to INVT Flex/TS/TM series

3.8.1.2 Component description



Name		Description	
Status indicator	R: Yellow green	Power-on/Run indicator status	On: The module is running.
			Slow flashing (2.5Hz): The module is establishing communication.
			Off: The module is not powered on or it is abnormal.
	E: Red	Module fault indicator	Off: The module works normally.
			Fast blinking (10Hz): The module is offline.
			Slow blinking (2.5Hz): Error in temperature detection.
	00–03: Green	Channel status indicator	On: The channel is enabled.
			Slow blinking (2.5Hz): Input signal out of range or limit.
			Fast blinking (10Hz): Disconnection.
Off: The channel is disabled.			
User terminal	External wiring I/O terminal		

Name	Description	
Color meaning	 Digital input	 Digital output (source, sink, relay)
	 Analog input (voltage, current, thermocouple)	 Analog output

3.8.1.3 Power supply specifications

Item	Specifications
Fieldbus input power rated voltage	5VDC (4.75VDC–5.25VDC)
Fieldbus input power rated current	250mA
Terminal input power rated voltage	None
Terminal input power rated current	None
Terminal output power rated voltage	None
Terminal output power rated current	None
Hot swapping of module	Not supported

3.8.1.4 Input specifications

Item	Specifications
Input channel	4
Resolution	24 bits
Display sensitivity	0.0625°C, 0.0625°F
Input terminal	4 thermocouple inputs
Thermocouple type	B, E, N, J, K, R, S, T
Compensation method	Internal cold junction compensation
Accuracy in room temperature (of 25°C)	Full scale * (±0.1%) + Cold junction compensation error
Accuracy (in room temperature -20°C–55°C)	Full scale * (±0.3%) + Cold junction compensation error
Isolation	I/O terminals insulated from the power supply; <input checked="" type="checkbox"/> No insulation between channels
Input action display	None
Input derating	None
Over-limit and disconnection detection	Supported

3.8.1.5 Cold junction compensation

Installation direction	Cold junction compensation error (-20°C–55°C)
Horizontal and upright installation	±3°C
Non-horizontal but upright installation	±6°C

3.8.1.6 Software specifications

Item	Specifications
Configuration of diagnosis reporting	Supported
Configuration of enabling diagnosis detection	Over-limit detection and disconnection detection supported
Sensor type configuration	Supported thermocouple types: B, E, N, J, K, R, S, T
Filter parameter	1–255 (Default: 8)
Overflow and underflow detection	Not supported
Configuration of enabling over-limit detection	Supported
Independent channel configuration	Supported
Configuration of enabling temperature offset	Supported
Temperature setting range	-204.8–204.7 temperature unit
Sampling period	360ms/channel
Display method	Celsius degree (°C), Fahrenheit degree (°F)
Sensitivity	0.0625°C, 0.0625°F
Sampling refresh	Sampling time based asynchronous refresh, but not bus period based synchronous refresh
Disconnection or over-limit	Output of max. value plus 10°C
System diagnosis	Not supported
Channel diagnosis	Upper limit exceeding alarm, lower limit exceeding alarm, and disconnection alarm
Software diagnosis	Not supported
Configuration diagnosis	Identifying configuration errors, including channel parameter configuration errors



3.8.1.7 Environment requirements

Item	Specifications
Working environment temperature	-20°C–55°C
Working environment relative humidity (RH)	RH < 95%, no condensation
Storage temperature	-40°C–70°C (RH < 90%, no condensation)
Air	No corrosive gas
Altitude	Lower than 3000m
Pollution degree	Below degree 2
Immunity	2kV power cable compliant with IEC61000-4-4
Overvoltage category	Category II
EMC anti-interference level	Zone B, compliant with IEC61131-2
vibration resistance	Compliant with IEC 60068-2-6
Impact resistance	Compliant with IEC 60068-2-27

4 Installation

4.1 Preparing



4.1.1 Installation precautions

Before installation	
	<ul style="list-style-type: none"> • Make sure all product modules have been powered off before installation. • Check the planned overall size and ensure that there is enough space to accommodate the product modules. The module must be installed in a cabinet with each clearance to the surrounding greater than 50mm so that the product hardware has good heat dissipation.
During installation	
	<ul style="list-style-type: none"> • During installing, use the installation tools that meet the requirements, such as screws and gaskets. • Prevent metal wire heads, debris, screws, and other objects from falling into the internal of the product. Otherwise, short circuit may occur, or heat dissipation may be degraded.
After installation	
	<ul style="list-style-type: none"> • Ensure that the terminal of the connected communication cable is firmly fastened. • Ensure that the rail that hosts the module is reliably fixed. • Ensure that the strong-electricity cables are separately routed from the weak-electricity cables, and the cables are routed neatly in the cabinet. • Remove the sticker attached to the heat dissipation hole of the module to make the heat dissipation smooth. • After installation, check the air circulation around the module.



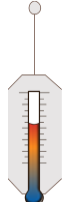

4.1.2 Installation environment and site

Check the installation environment and ensure that the environment meets the working conditions of all the components of the product, which include temperature, humidity, dust and corrosion protection requirements.

- **Environment requirements**

Environment	Requirement	
Temperature		<ul style="list-style-type: none"> • -20°C–55°C • There is no sudden temperature change. • When the product is installed in a closed space, such as control cabinet, use a cooling fan or air conditioner for temperature adjustment if necessary.
Relative humidity (RH)		<ul style="list-style-type: none"> • RH: 5%–95%, no condensation

- **Location requirement**

Location	Requirement	
Indoor, overvoltage class II		<ul style="list-style-type: none"> ● No strong electric field, strong magnetic field, or direct sunlight
		<ul style="list-style-type: none"> ● No dust, conductive powder such as iron powder, oil mist, salt, or organic solvent
		<ul style="list-style-type: none"> ● No corrosive gas or flammable gas
		<ul style="list-style-type: none"> ● No factors that will cause the machine to directly vibrate or suffer conductive shocks

4.1.3 Installation space

Sufficient space should be reserved between the top and bottom of the module and the housing and other components to facilitate product replacement, ventilation, and heat dissipation.

Figure 4-1 Installation space (Unit: mm)

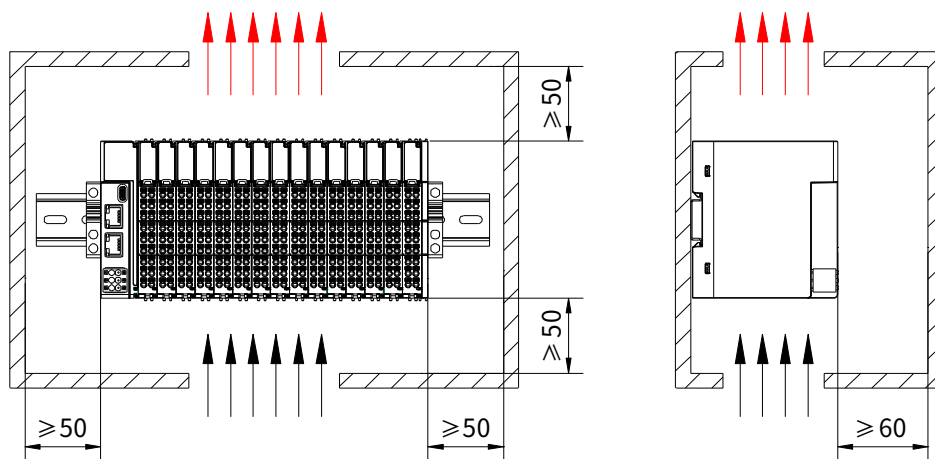

4.2 Installation dimensions

4.2.1 Communication coupler

4.2.1.1 Module installation dimensions

The dimensions are applicable to FK1100 and FK1200.

Figure 4-2 Module installation dimensions (Unit: mm)

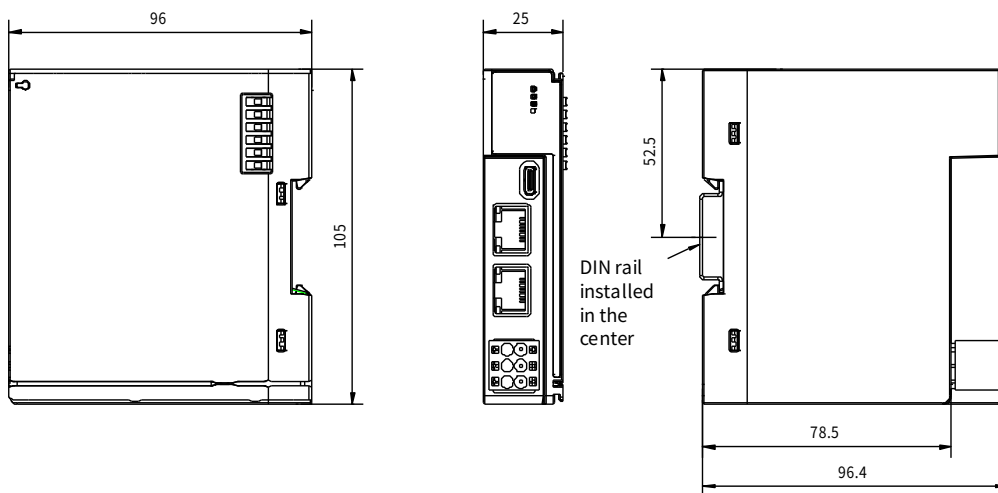

4.2.1.2 Connection cable dimensions

Figure 4-3 Connection cable dimensions (Unit: mm)

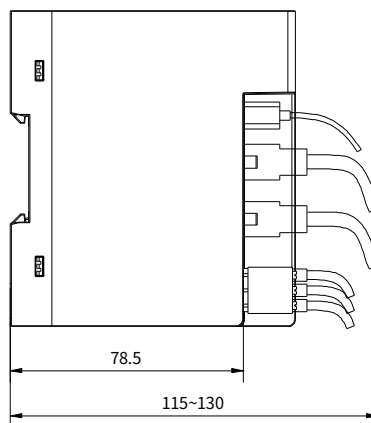

4.2.1.3 End cover dimensions

Figure 4-4 End cover dimensions (Unit: mm)

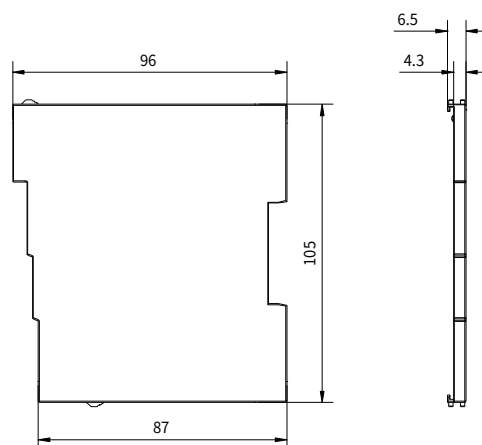

4.2.2 I/O module

4.2.2.1 Module installation dimensions

The dimensions are applicable to FL1001, FL2002, FL2102, FL3003, FL3103, FL3203, and FL4003.

Figure 4-5 Module installation dimensions (Unit: mm)

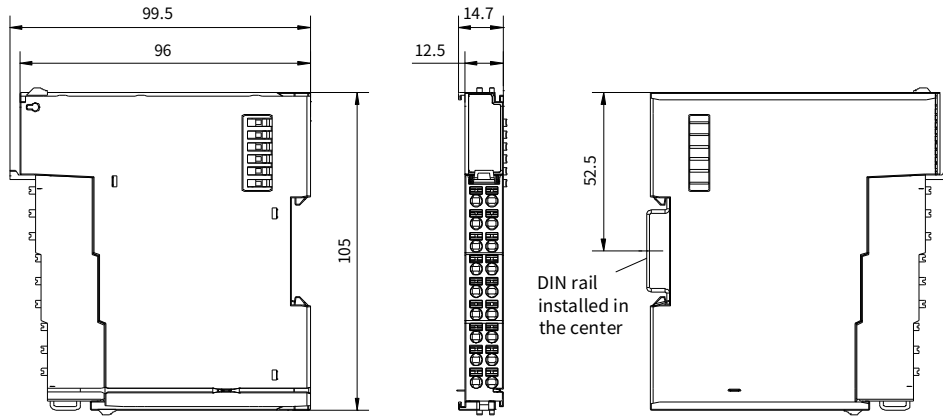

The dimensions are applicable to FL2201.

Figure 4-6 Module installation dimensions (Unit: mm)

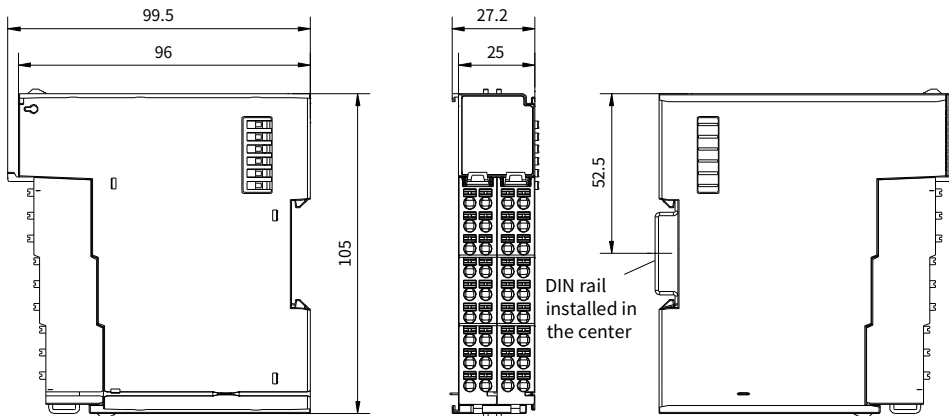

4.2.2.2 Connection cable dimensions

Figure 4-7 Connection cable dimensions (Unit: mm)

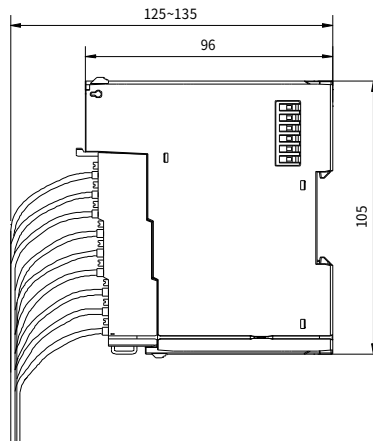

4.3 DIN rail model selection

You can refer to the following table to select the applicable DIN rail model.

Model	Length x Height (unit: mm)	Fastening screw
TH35-7.5Fe	35x7.5	M4
TH35-7.5A1	35x7.5	M4
TH35-15Fe	35x15	M4

Figure 4-8 DIN rail installation dimensions (Unit: mm)

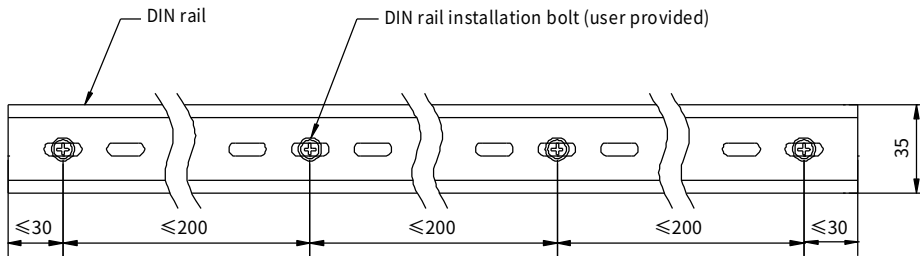

To ensure the strength of the DIN rail, install the DIN rail installation bolts (provided by yourself) at the places within 30mm from both ends of the DIN rail, (for details, see Figure 4-8), and ensure that the interval between two adjacent bolts must be within 200mm.

4.4 Installation

The installation procedure is as follows:

Step 1 Slide the right end cover of the communication coupler forward and remove it.

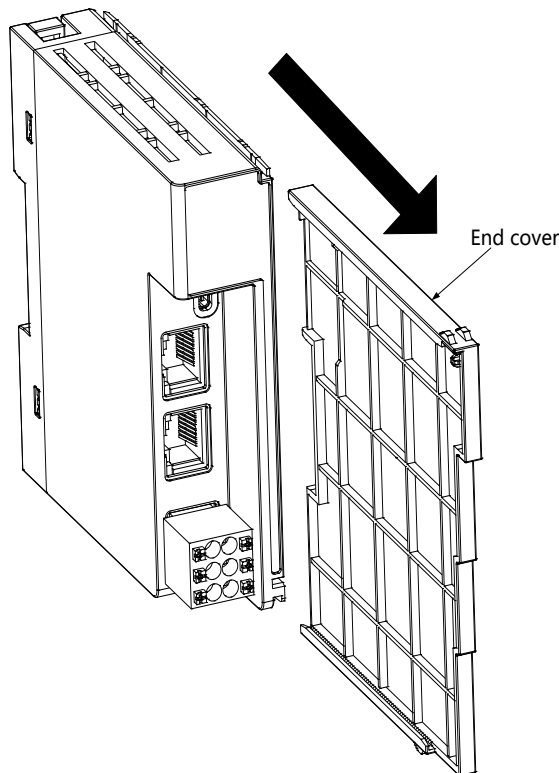

Step 2 Align the communication coupler module with the DIN rail and press inward until the module engages with the DIN rail (there is a noticeable sound of engagement when installed in place).

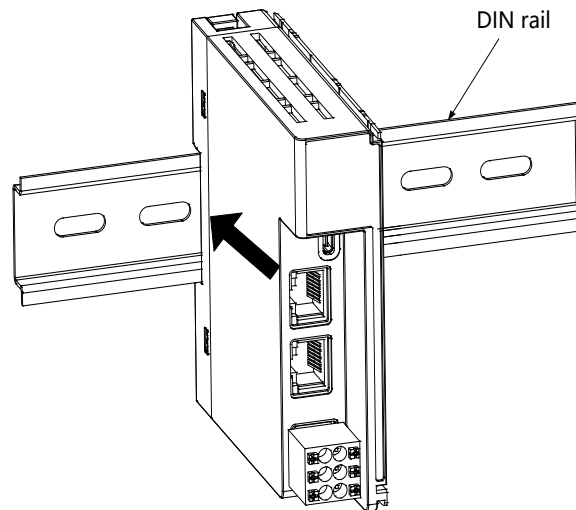

Step 3 Align the module with connection slots with the sliding slots of the module fixed on the DIN rail, and push it inward until the module with connection slots engages with the DIN rail (there is a noticeable sound of engagement when installed in place).

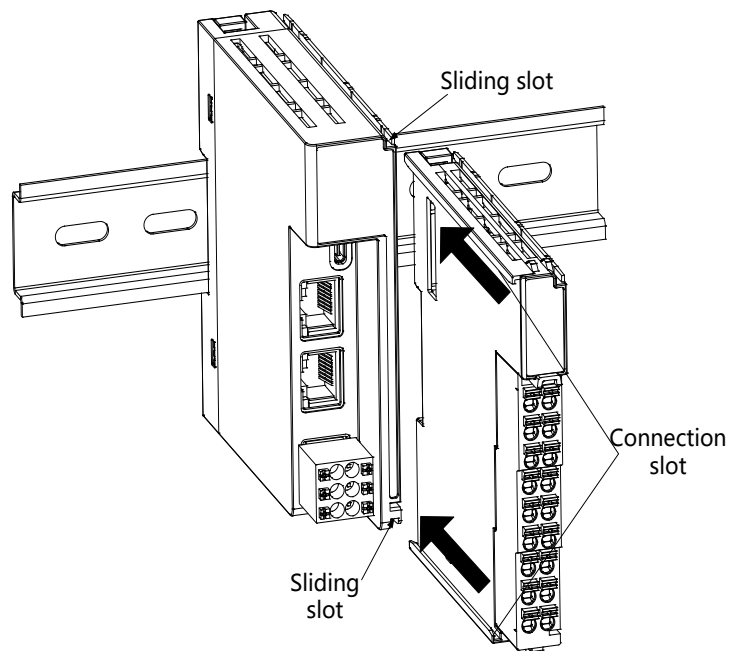

Step 4 Slide the end cover with connection slots into the last I/O module.

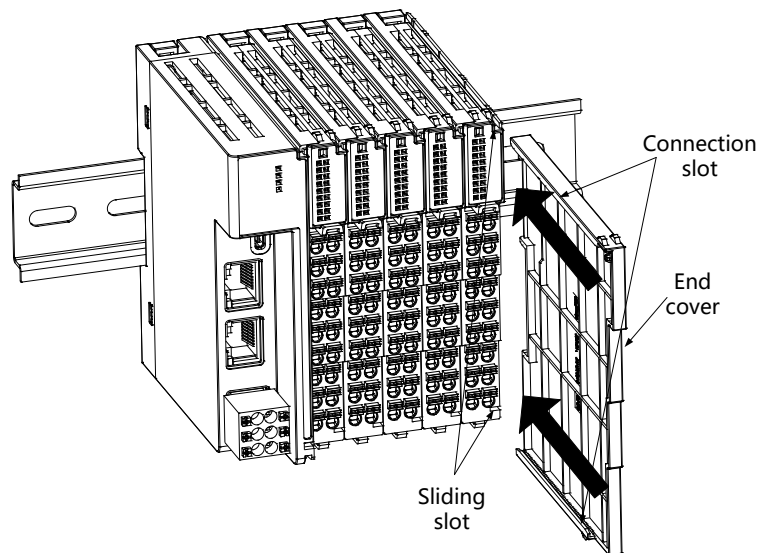

Note: The metal pins on the last I/O module must not be exposed outside.

Step 5 Install a guide rail fixing clip at the head and tail of the module assembly to prevent it from sliding leftward or rightward.

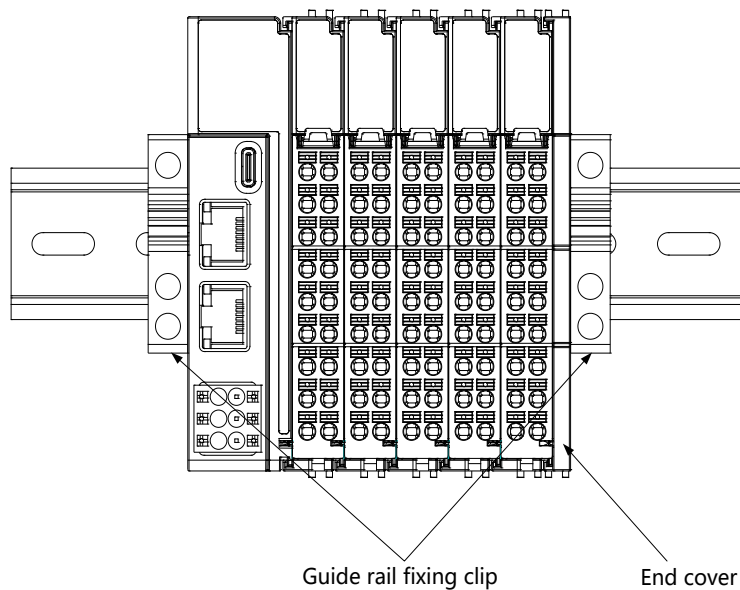

Note:

- Before installing the module, remove the end cover before proceeding with the next step. Install the end cover on the rightmost module.
- After the module installation is completed, the rail latch will automatically lock. If the rail latch is not locked with the DIN rail, press the top of the latch towards the rail to ensure proper installation.
- The rail fixing clip is user purchased.

4.5 Disassembly

The disassembly procedure is as follows:

Step 1 Loosen the rail fixing clip to ensure that there is sufficient clearance to pull away the module from the DIN rail.

Note: The rail fixing clip is user purchased.

Step 2 Use a flat screwdriver or other similar tool to pry up the upper and lower rail latches separately.

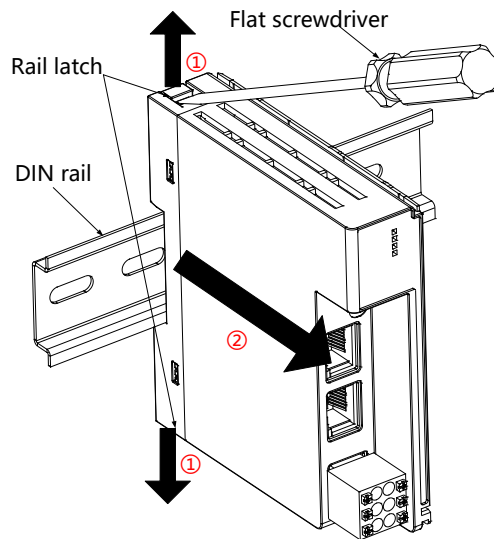

Step 3 Pull the module out in the direction perpendicular to the DIN rail.

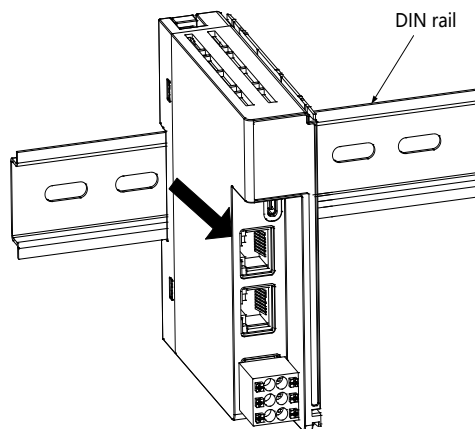

Note: Refer to step 1 in [4.4 Installation](#) to remove the end cover.

5 Wiring

5.1 Wiring requirements

- Before wiring, ensure that all external power supplies have been cut off.
- After completing the wiring, ensure the module top end cover has been installed properly before powering on or operating the module. Otherwise, electric shock or maloperation can result.
- Before wiring, check the rated voltage and terminal configuration according to product specifications to ensure safe wiring. The connection to a power supply that does not match the ratings or incorrect product wiring may cause serious accidents such as fire and product damage.
- Tighten up screws according to specified torque. If screws are loose, short circuit, fire, or maloperation may result.

 **Note:** If terminal screws are too tightened, screw or module damage, falling, short circuit, or faults may result.

- Ensure that there are no foreign objects such as metal scraps or wiring residues in each module. The foreign objects may cause short circuit, fire, or maloperation.

5.2 Grounding requirements

- **Power cable grounding**
 - ✧ Use correct, independent wiring methods.
 - ✧ Connect a cable with the cross-sectional area $\geq 2\text{mm}^2$ and length $\leq 30\text{cm}$ for grounding, and ground power supply module terminal .
 - ✧ If the grounding point is close to the product, ensure that the grounding cable is secure.
- **Shielded cable grounding**
 - ✧ Use shielded cables for analog I/O, RS485, and EtherCAT cables and other cables that transmit sensitive signals.
 - ✧ The grounding point should be as close as possible to the module.
 - ✧ For the shield part exposed after some of the shield cable is stripped, ground the part and the conductive backplane with an area as large as possible to ensure good contact.

5.3 Cable specifications

Cable material	Cable diameter		Crimping tool
	mm ²	AWG	
Tubular cable lug	0.3	22	Use a proper crimping plier.
	0.5	20	
	0.75	18	
	1.0	18	
	1.5	16	

 **Note:**

- The cable diameters of the tubular cable lugs in the preceding table is only for reference, which can be

adjusted based on actual situations.

- When using other tubular cable lugs, crimp multiple strands of cable, and the processing size requirements are as follows:

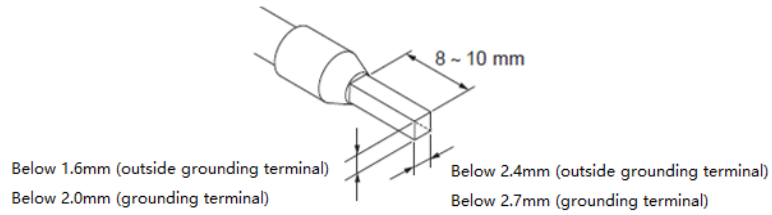

5.4 Terminal definition and wiring

5.4.1 Communication coupler (of EtherCAT/PROFINET)

- Terminal definition

Schematic diagram	Left signal	Left terminal	Right terminal	Right signal
	24V	-	-	24V
	0V	-	-	0V
	⊕	-	-	⊕

- Terminal wiring

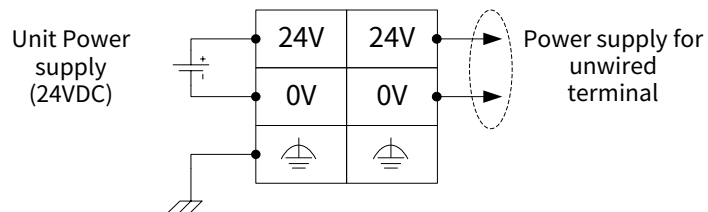

5.4.2 Digital input module

5.4.2.1 FL1001 (1600D)

- Terminal definition

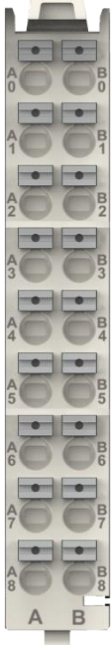
Schematic diagram	Left signal	Left terminal	Right terminal	Right signal
	DI0	A0	B0	DI10
	DI1	A1	B1	DI11
	DI2	A2	B2	DI12
	DI3	A3	B3	DI13
	DI4	A4	B4	DI14
	DI5	A5	B5	DI15
	DI6	A6	B6	DI16
	DI7	A7	B7	DI17
	SS	A8	B8	SS

- Terminal wiring

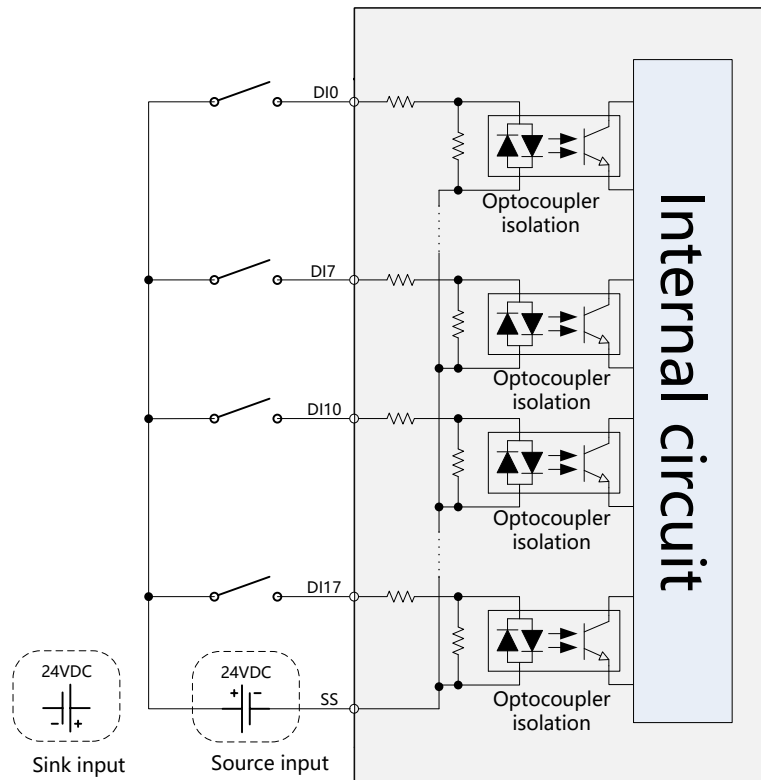

5.4.3 Digital output module (Source type)

5.4.3.1 FL2002 (0016DP)

- Terminal definition

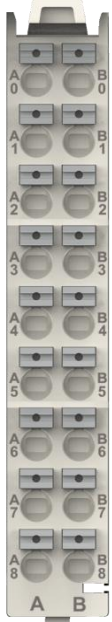
Schematic diagram	Left signal	Left terminal	Right terminal	Right signal
	DO0	A0	B0	DO10
	DO1	A1	B1	DO11
	DO2	A2	B2	DO12
	DO3	A3	B3	DO13
	DO4	A4	B4	DO14
	DO5	A5	B5	DO15
	DO6	A6	B6	DO16
	DO7	A7	B7	DO17
	24VDC	A8	B8	COM

- Terminal wiring

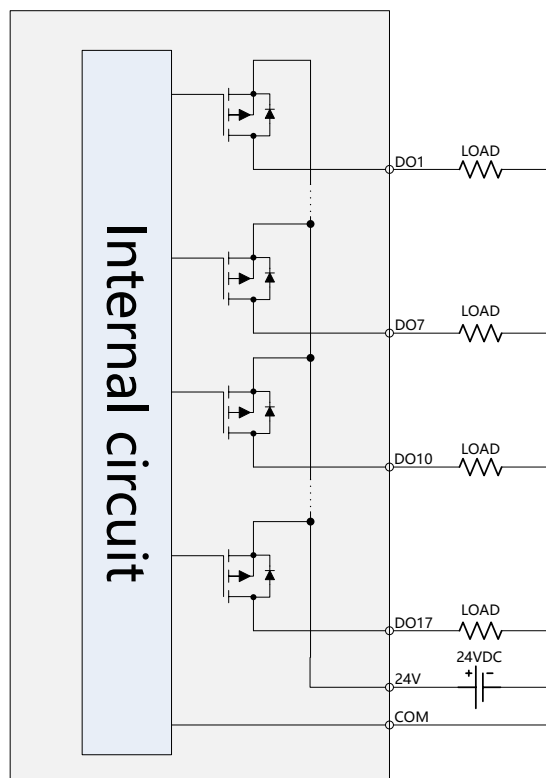

5.4.4 Digital output module (Sink type)

5.4.4.1 FL2102 (0016DN)

- Terminal definition

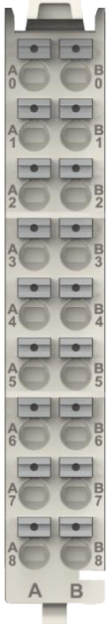
Schematic diagram	Left signal	Left terminal	Right terminal	Right signal
	DO0	A0	B0	DO10
	DO1	A1	B1	DO11
	DO2	A2	B2	DO12
	DO3	A3	B3	DO13
	DO4	A4	B4	DO14
	DO5	A5	B5	DO15
	DO6	A6	B6	DO16
	DO7	A7	B7	DO17
	COM	A8	B8	COM

- User terminal wiring

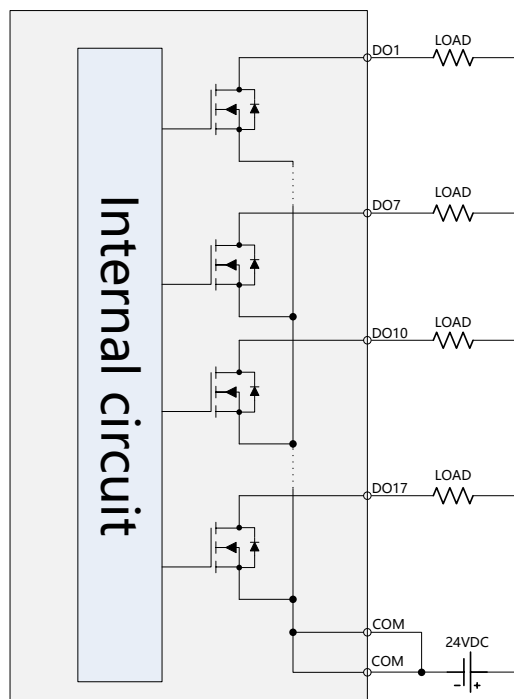

5.4.5 Digital output module (Relay)

5.4.5.1 FL2201 (0008DR)

- Terminal definition

Schematic diagram	Left signal	Left terminal	Right terminal	Right signal
	Y00	A0	B0	COM0
	-	A1	B1	-
	Y01	A2	B2	COM0
	-	A3	B3	-
	Y02	A4	B4	COM0
	-	A5	B5	-
	Y03	A6	B6	COM0
	-	A7	B7	-
	-	A8	B8	-
	Y04	C0	D0	COM1
	-	C1	D1	-
	Y05	C2	D2	COM1
	-	C3	D3	-
	Y06	C4	D4	COM1
	-	C5	D5	-
	Y07	C6	D6	COM1
-	C7	D7	-	
-	C8	D8	-	

- Terminal wiring

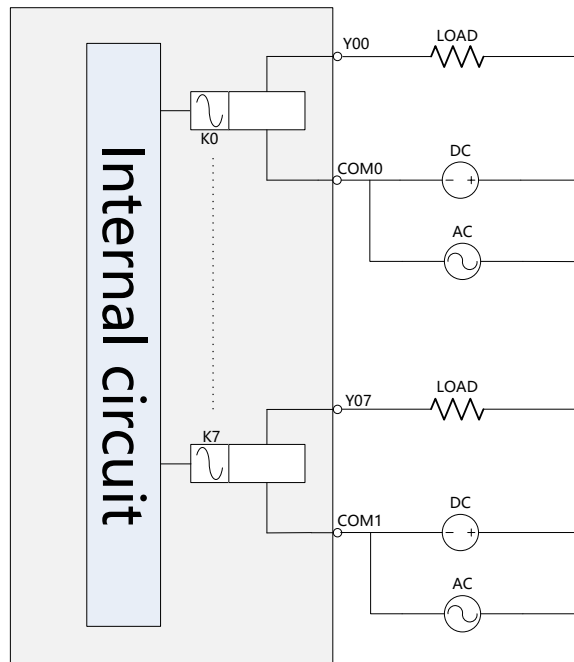

5.4.6 Analog input module

5.4.6.1 FL3003 (4AD)

- Terminal definition

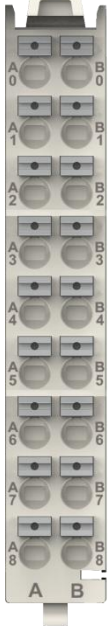
Schematic diagram	Left signal	Left terminal	Right terminal	Right signal
	V10+	A0	B0	I0+
	V10-	A1	B1	PE
	V11+	A2	B2	I1+
	V11-	A3	B3	PE
	V12+	A4	B4	I2+
	V12-	A5	B5	PE
	V13+	A6	B6	I3+
	V13-	A7	B7	PE
	-	A8	B8	-

- Terminal wiring

Figure 5-1 Voltage input wiring

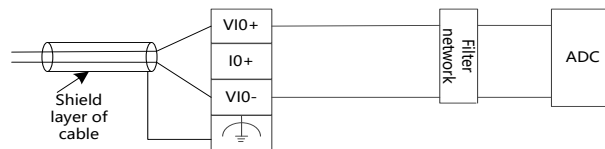
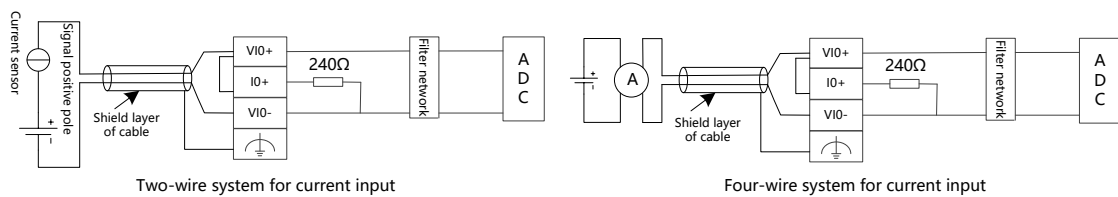

Figure 5-2 Current input wiring



5.4.7 Analog output module

5.4.7.1 FL4003 (4DA)

- Terminal definition

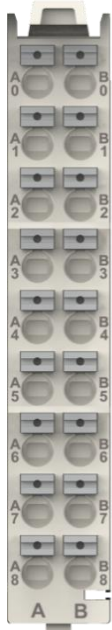
Schematic diagram	Left signal	Left terminal	Right terminal	Right signal
	V0+	A0	B0	VI0-
	I0+	A1	B1	PE
	V1+	A2	B2	VI1-
	I1+	A3	B3	PE
	V2+	A4	B4	VI2-
	I2+	A5	B5	PE
	V3+	A6	B6	VI3-
	I3+	A7	B7	PE
	24V	A8	B8	COM

- Terminal wiring

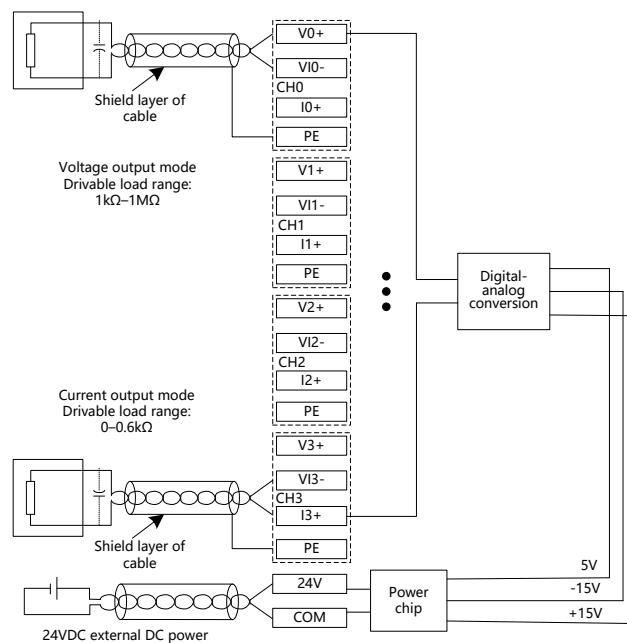

5.4.8 Temperature detection module (Thermal resistor)

5.4.8.1 FL3103 (4PT)

- Terminal definition

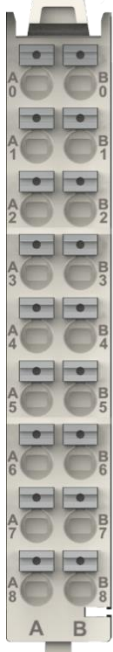
Schematic diagram	Left signal	Left terminal	Right terminal	Right signal
	I0+	A0	B0	I0-
	R0+	A1	B1	R0-
	I1+	A2	B2	I1-
	R1+	A3	B3	R1-
	I2+	A4	B4	I2-
	R2+	A5	B5	R2-
	I3+	A6	B6	I3-
	R3+	A7	B7	R3-
	PE	A8	B8	PE

- Terminal wiring

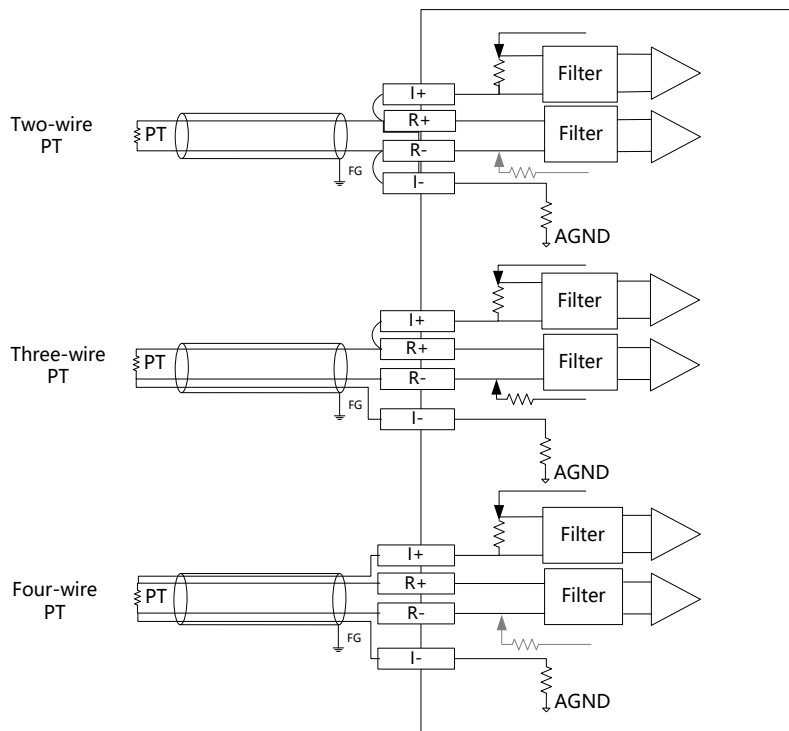

5.4.9 Temperature detection module (Thermocouple)

5.4.9.1 FL3203 (4TC)

- Terminal definition

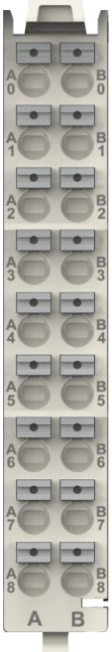
Schematic diagram	Left signal	Left terminal	Right terminal	Right signal
	CH0+	A0	B0	CH0-
	CH1+	A1	B1	CH1-
	CH2+	A2	B2	CH2-
	CH3+	A3	B3	CH3-
	-	A4	B4	-
	-	A5	B5	-
	-	A6	B6	-
	-	A7	B7	-
	-	A8	B8	-

- Terminal wiring

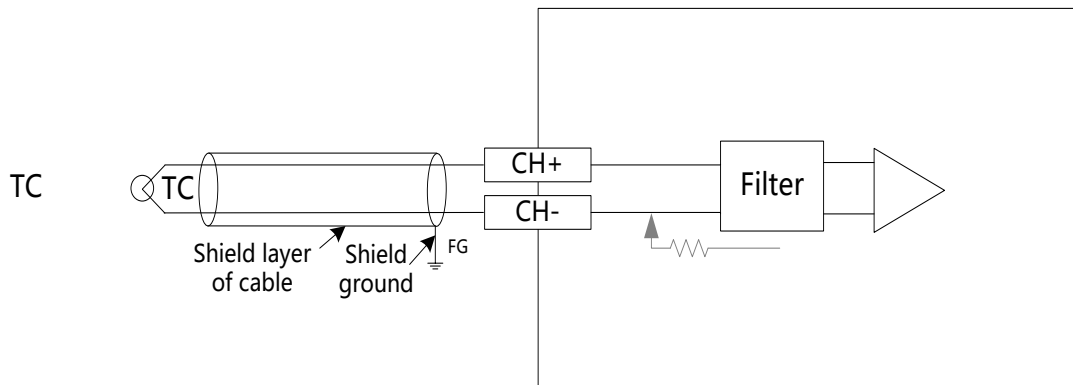

6 Product programming application

6.1 Communication coupler

6.1.1 FK1100 EtherCAT communication coupler

1. Device import

Step 1 Install the device description file named in the format of *FK1100_ECT_Coupler_x.x.x.x.xml*.

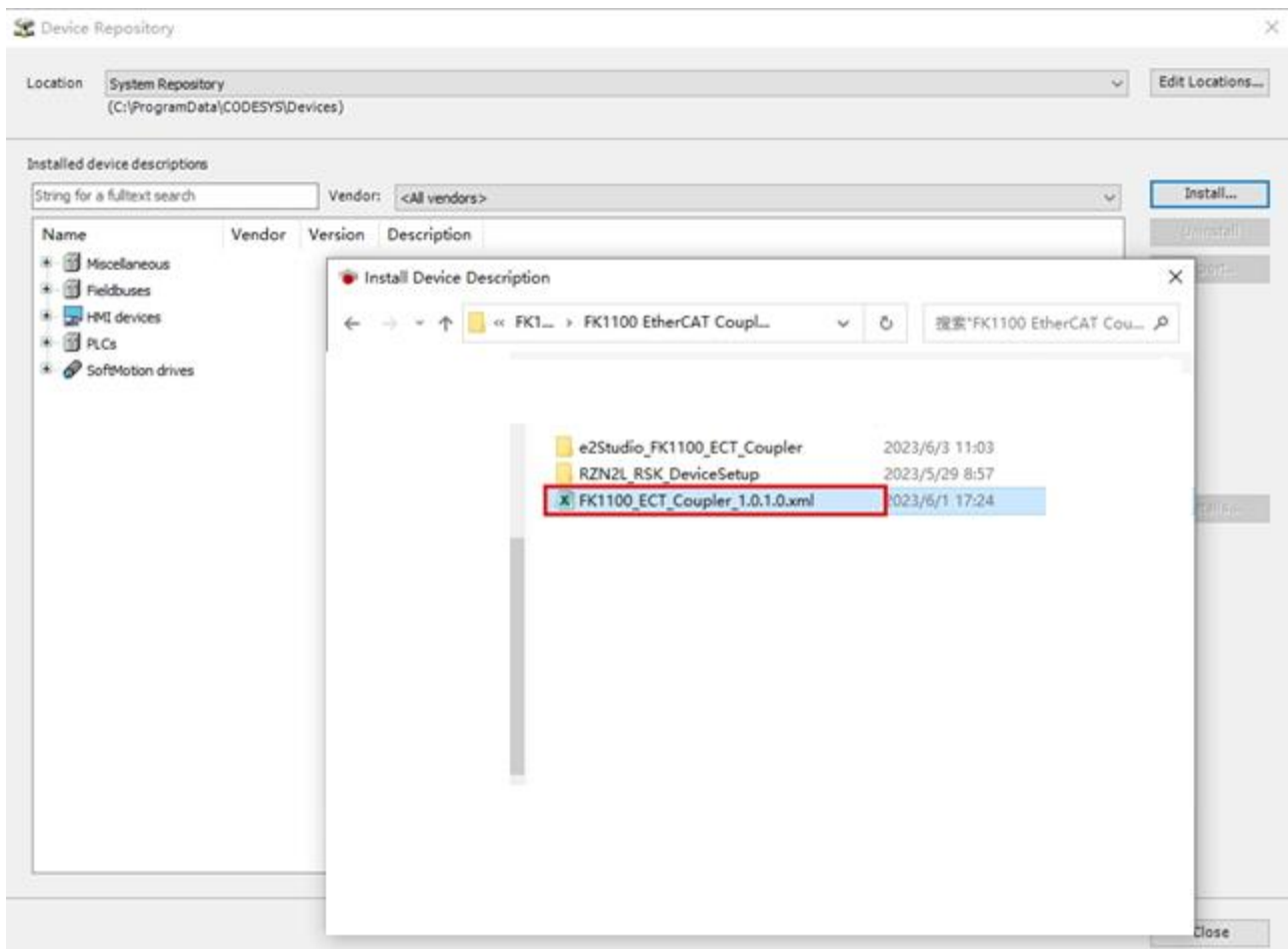

Step 2 Create a project, add the master and slave devices.

Add Device [Close]

Name:

Action: Append device Insert device Plug device Update device

String for a fulltext search: Vendor: <All vendors>

Name	Vendor	Version	Description
Miscellaneous			
Fieldbuses			
CANbus			
EtherCAT			
Master			
EtherCAT Master	3S - Smart Software Solutions GmbH	3.5.15.0	EtherCAT Master ...
EtherCAT Master SoftMotion	3S - Smart Software Solutions GmbH	3.5.15.0	EtherCAT Master SoftMotion...
Ethernet Adapter			
EtherNet/IP			
Home&Building Automation			
Modbus			
Profibus			
Profinet IO			
sercos			

Group by category Display all versions (for experts only) Display outdated versions

Name: EtherCAT Master SoftMotion
Vendor: 3S - Smart Software Solutions GmbH
Categories: Master
Version: 3.5.15.0
Order Number:
Description: EtherCAT Master SoftMotion...

Append selected device as last child of
Device

(You can select another target node in the navigator while this window is open.)

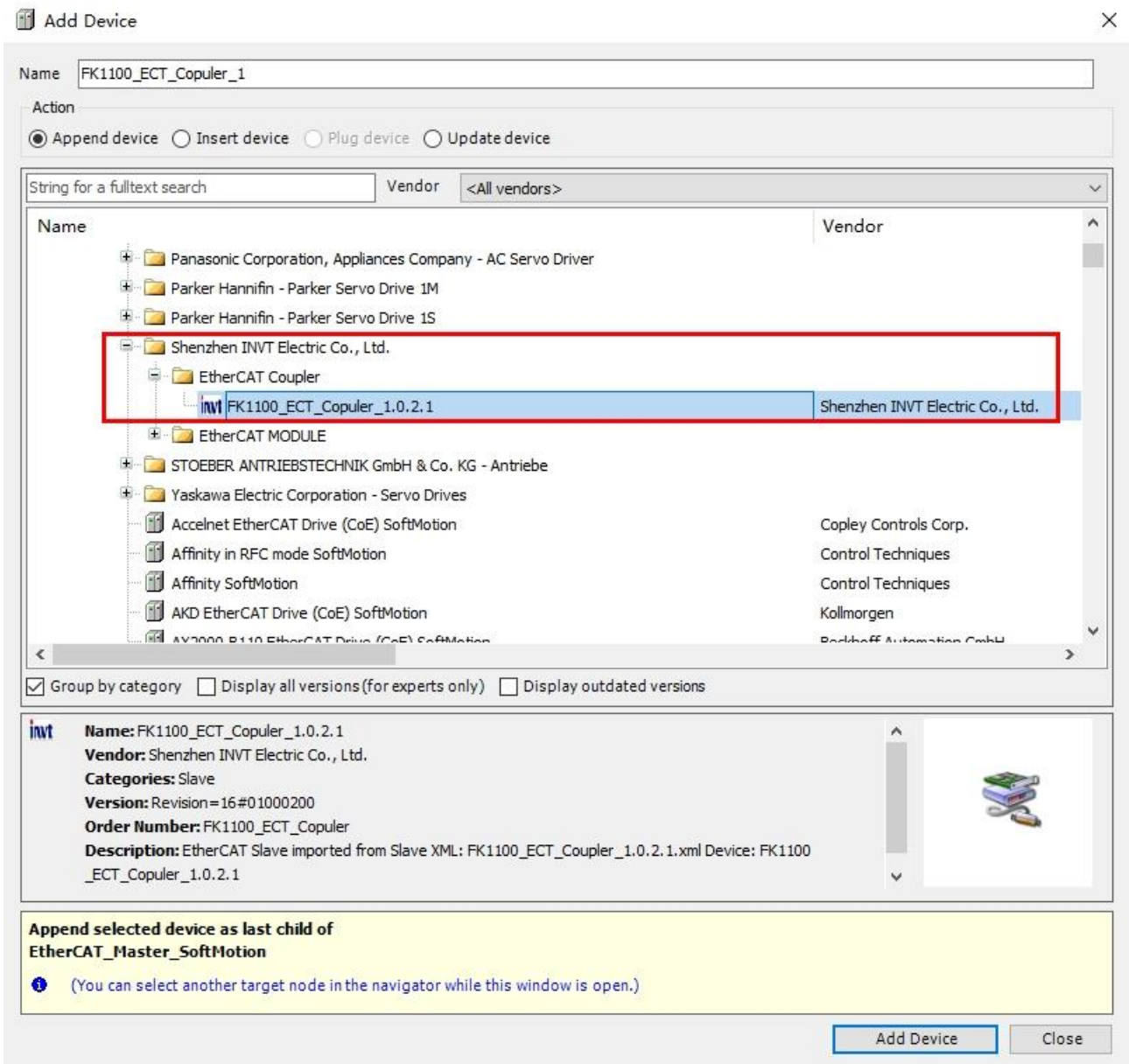

Step 3 Add module network configuration based on actual physical configuration (module connection).

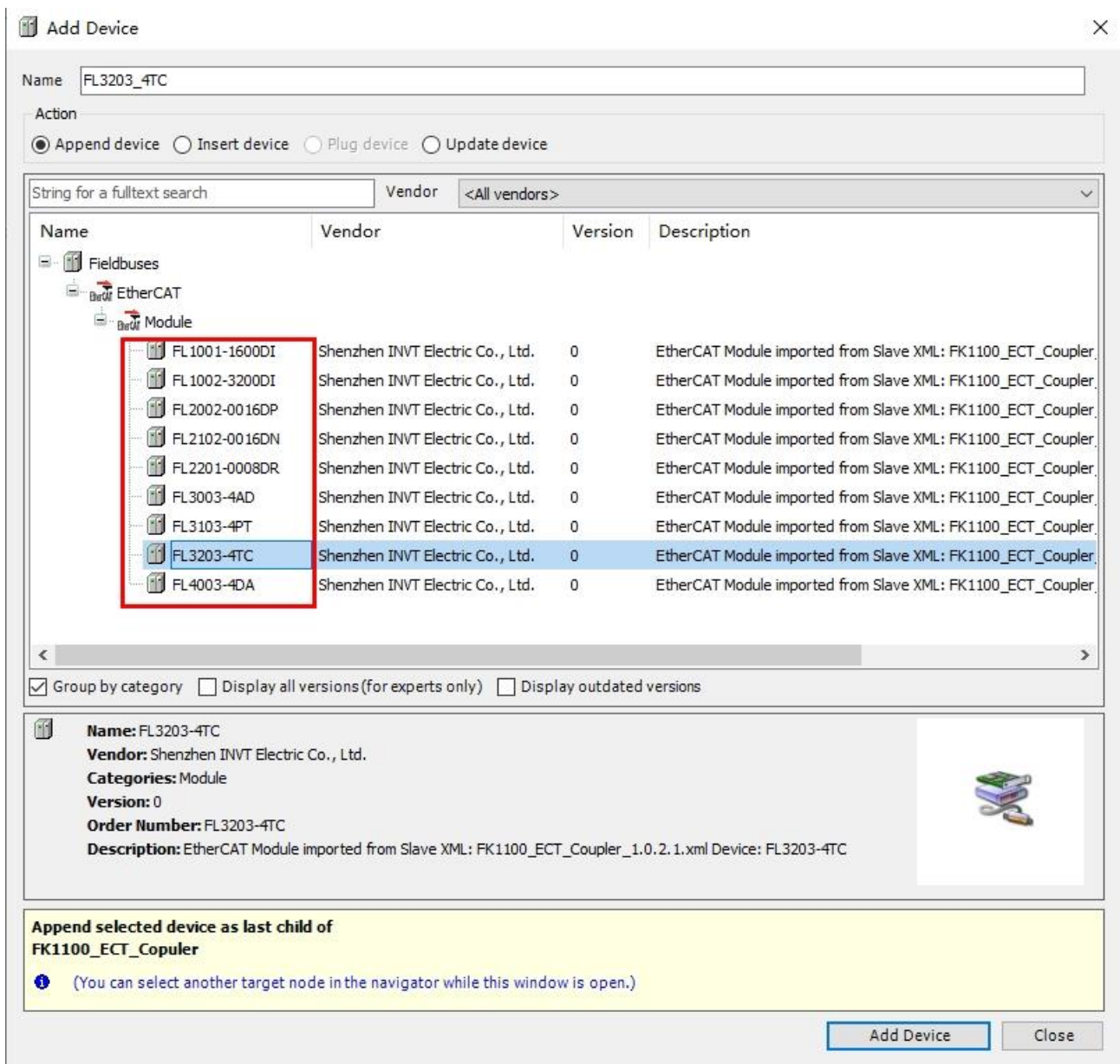

Step 4 After completing the module network configuration, set all configuration module parameters. Once compiled, the program can be downloaded and run.

Step 5 (Optional) Enable or disable the module based on actual needs.

2. Parameter description

Parameter	Type	Description				
Module Enable	UDINT	Control bit of expansion module enabling/disabling. Bit that controlling the enabling/disabling of the expansion module behind the coupler. Each bit controls the enabling/disabling of a module.				
		<table border="1"> <tr> <td>bit31</td> <td>...</td> <td>bit0</td> </tr> <tr> <td>Controls module 32.</td> <td>...</td> <td>Controls module 1.</td> </tr> </table>	bit31	...	bit0	Controls module 32.
bit31	...	bit0				
Controls module 32.	...	Controls module 1.				
Coupler Info.ActNum	UINT	Number of connected expansion modules.				
Coupler Info.HW Version	UINT	Coupler hardware version number.				

Parameter	Type	Description
Coupler Info.SW Version	USINT	Coupler software version number.
Coupler Info.FPGA Version	USINT	Coupler FPGA software version number.
Detected Module Ident List	/	Detection module ID list.
Detected Module Ident List .SubIndex 001	UDINT	ID of 1st module detected
Detected Module Ident List .SubIndex 002	UDINT	ID of 2nd module detected
...
Detected Module Ident List .SubIndex 032	UDINT	ID of 32nd module detected

6.1.2 FK1200 PROFINET communication coupler

1. Install the device description file named in the format of *GSDML-V2.43-INVT-FK1200-xxxxxxx.xml*.

Step 1 Choose **Option > Manage general station description files (GSD)** from the menu bar.

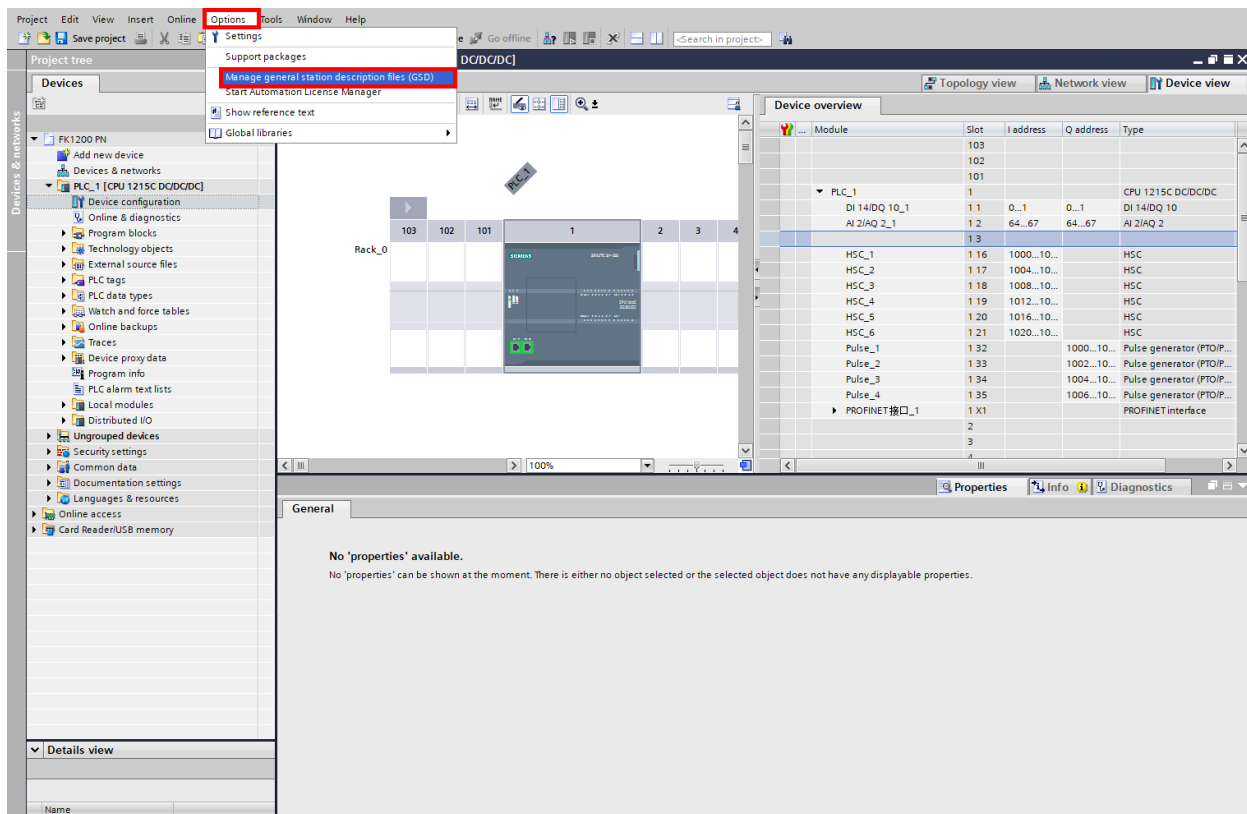

Step 2 In the **Manage general station description files** window that appears, set **Source path** to the GSD file saving path, select the GSD file to be installed, and then click **Install**.

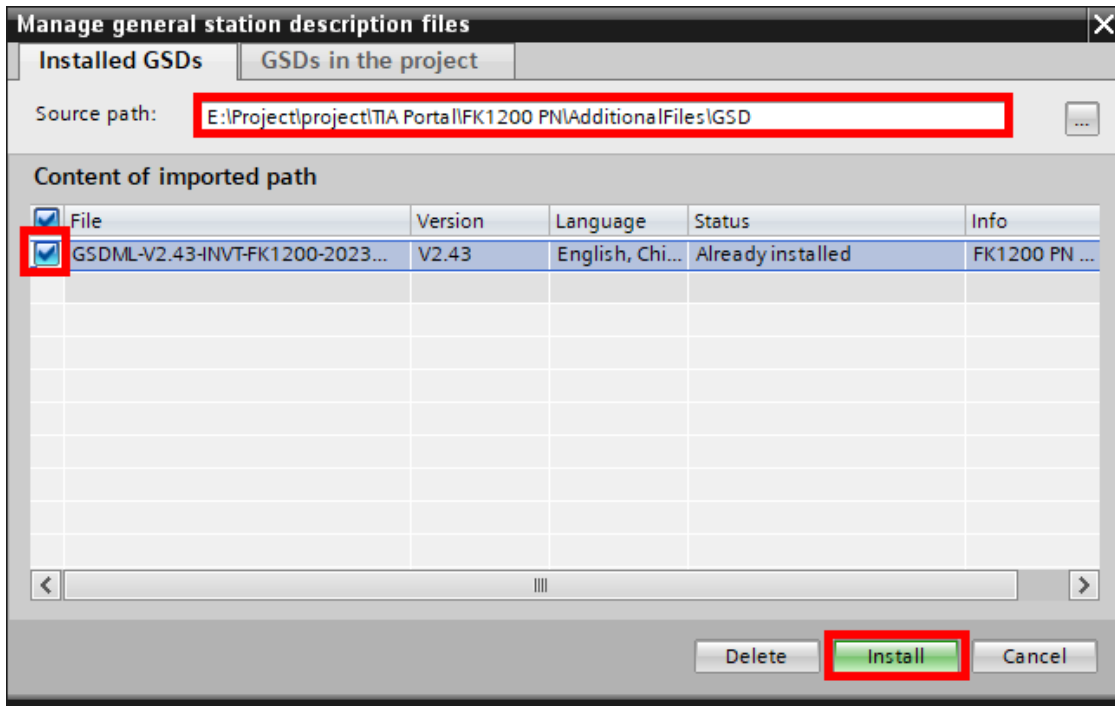

2. Set the PN device name and IP address.

Step 1 Complete the actual physical connection. Under **Project tree**, choose **Devices > Online access > Realtek PCIe GbE Family Controller > Update accessible devices**.

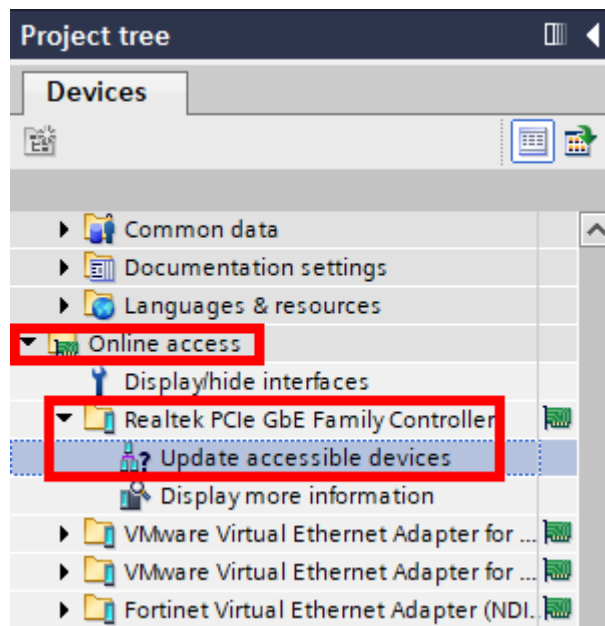

Step 2 Choose the refreshed PN coupler device (you can confirm the device according to the MAC address). Choose **Online & diagnostics** under **fk1200**, choose **Functions > Assign IP address**, set **IP address** and **Subnet mask**, and click **Assign IP address**. After the IP address assignment, choose **Assign PROFINET device name**, set **PROFINET device name**, and click **Assign name**.

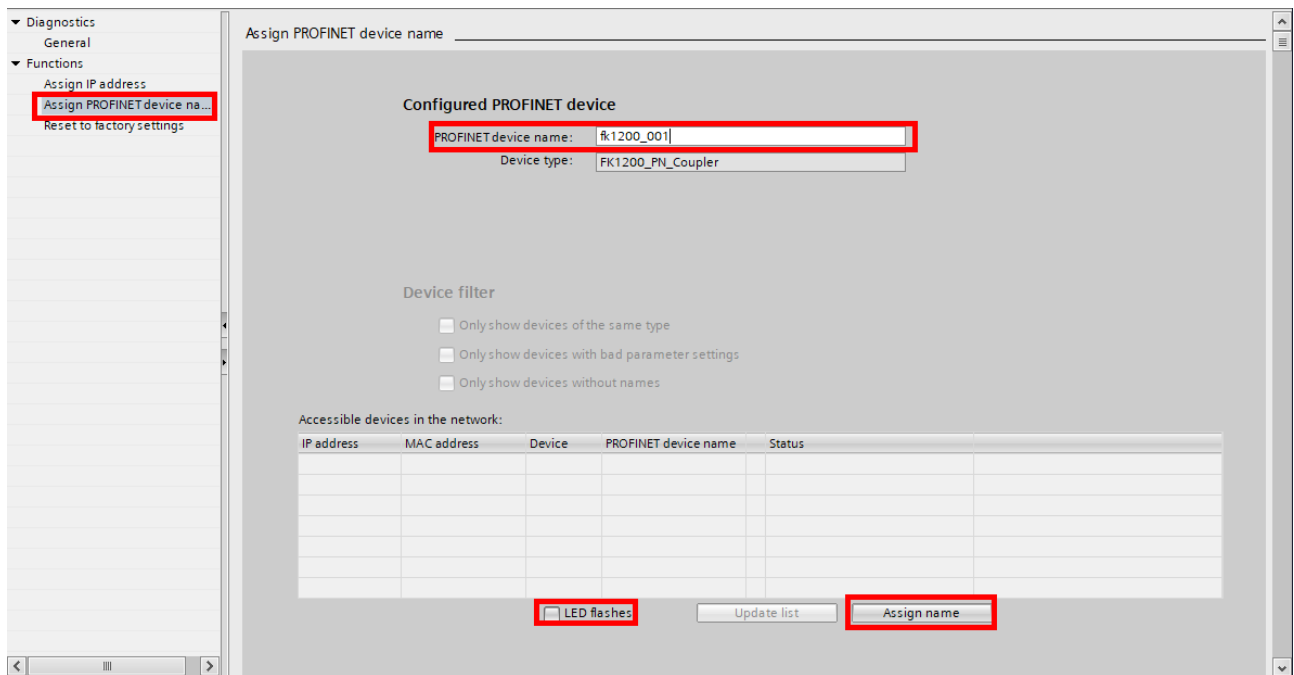
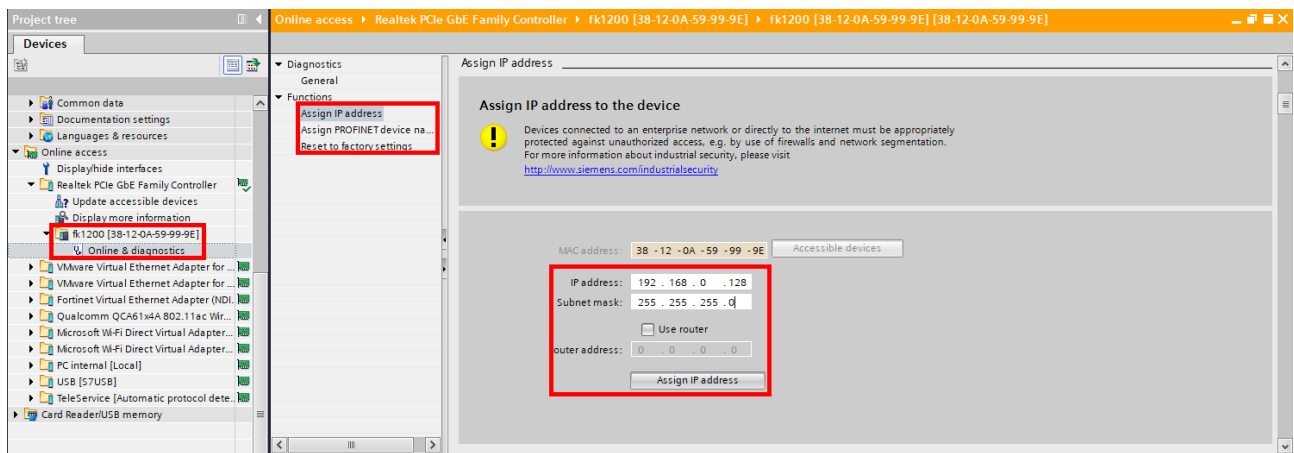

3. Network configuration

Step 1 Choose **PLC > Device configuration** on the left, click **Network view** in the main interface, click **Hardware catalog** on the right, choose **Other field devices > PROFINET IO > I/O > INVT > FK1200 > FK1200**.

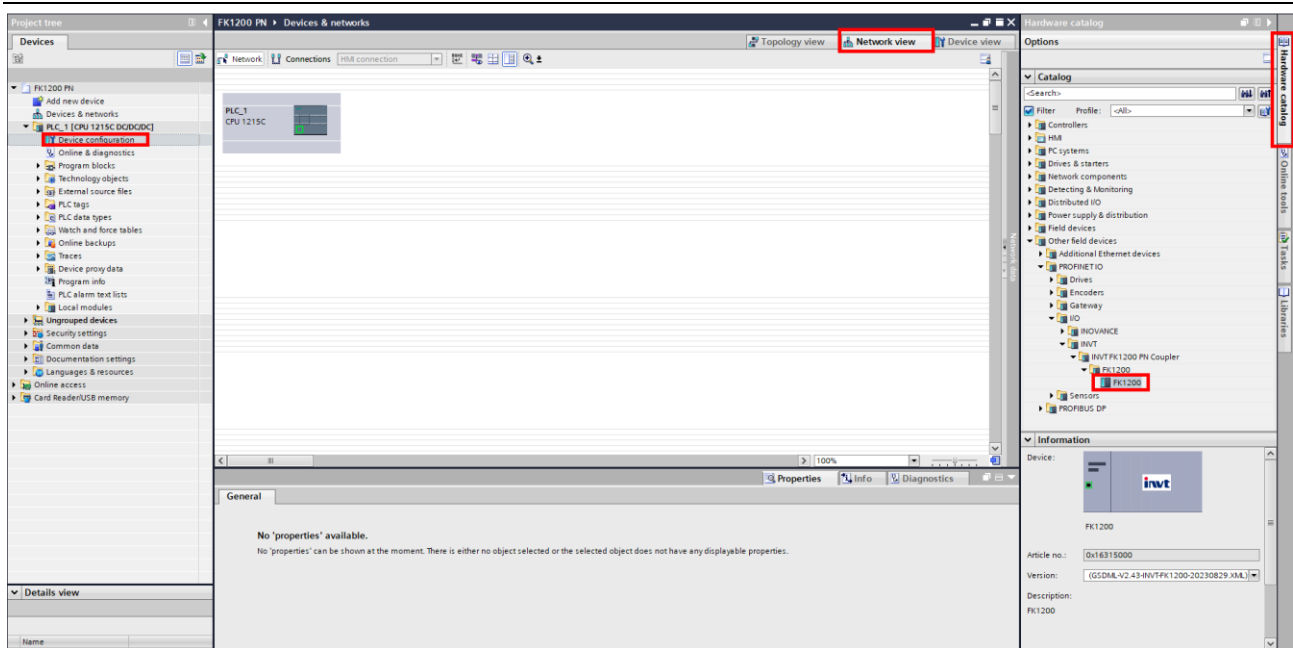

Step 2 Choose **PLC > Device configuration** on the left, click **Device view** in the main interface, choose the **FK1200** devices, and add modules to the slots according to actual physical configuration on the right.

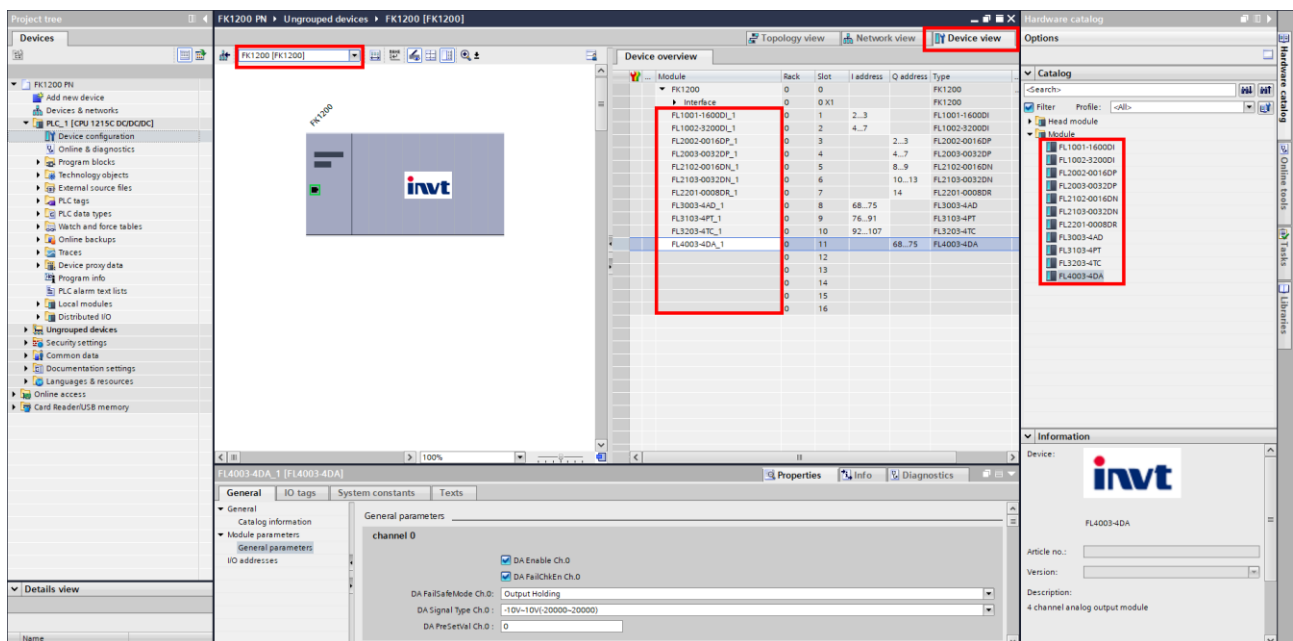

Step 3 In the **Device view** interface, double click **FK1200**. Under the lower part of interface, choose **Properties > General > PROFINET interface [X1] > Ethernet addresses**, deselect **Generate PROFINET device automatically**, and set **PROFINET device name** to the current device name.

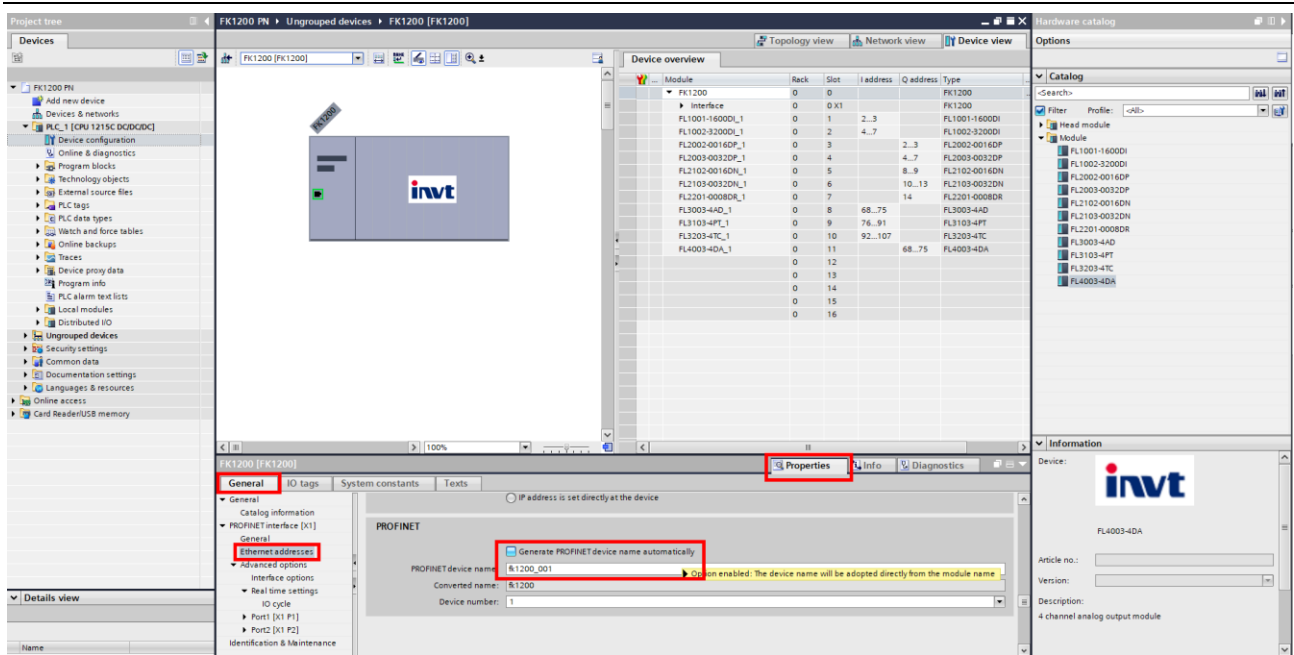

Note: In PROFINET communication, devices are identified through device names. Therefore, the set device names must match the actual device names of modules, and each device name must be unique.

Step 4 Set module parameters.

Example 1: In the **Device view** interface, double click **FL3003-4AD** under **Module**, choose **Properties > General > Module parameters**, and then set module initialization parameters.

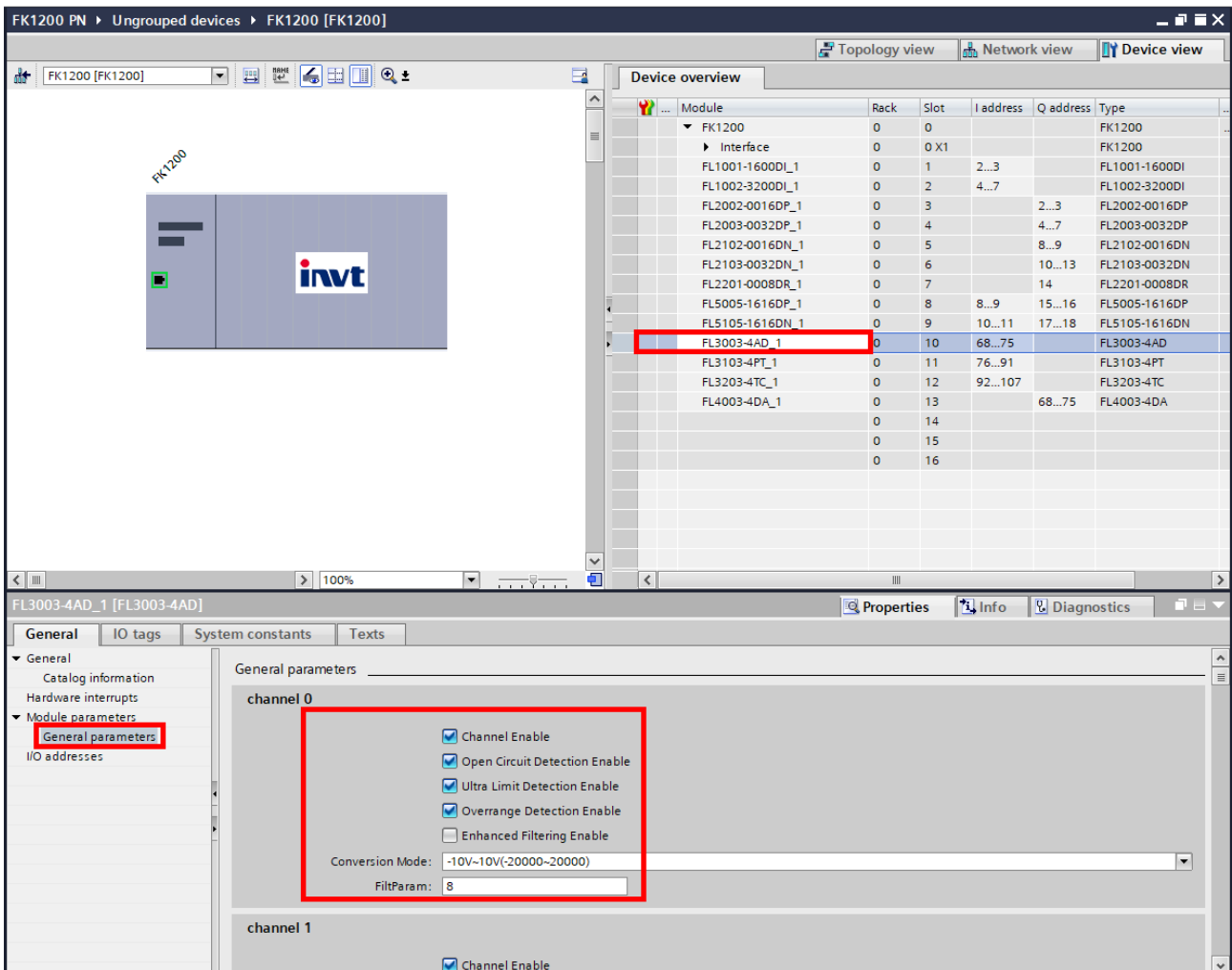

Example 2: In the **Device view** interface, double click **FL1001-1600DI** under **Module**, choose **Properties > General > Module parameters**, and then set module initialization parameters.

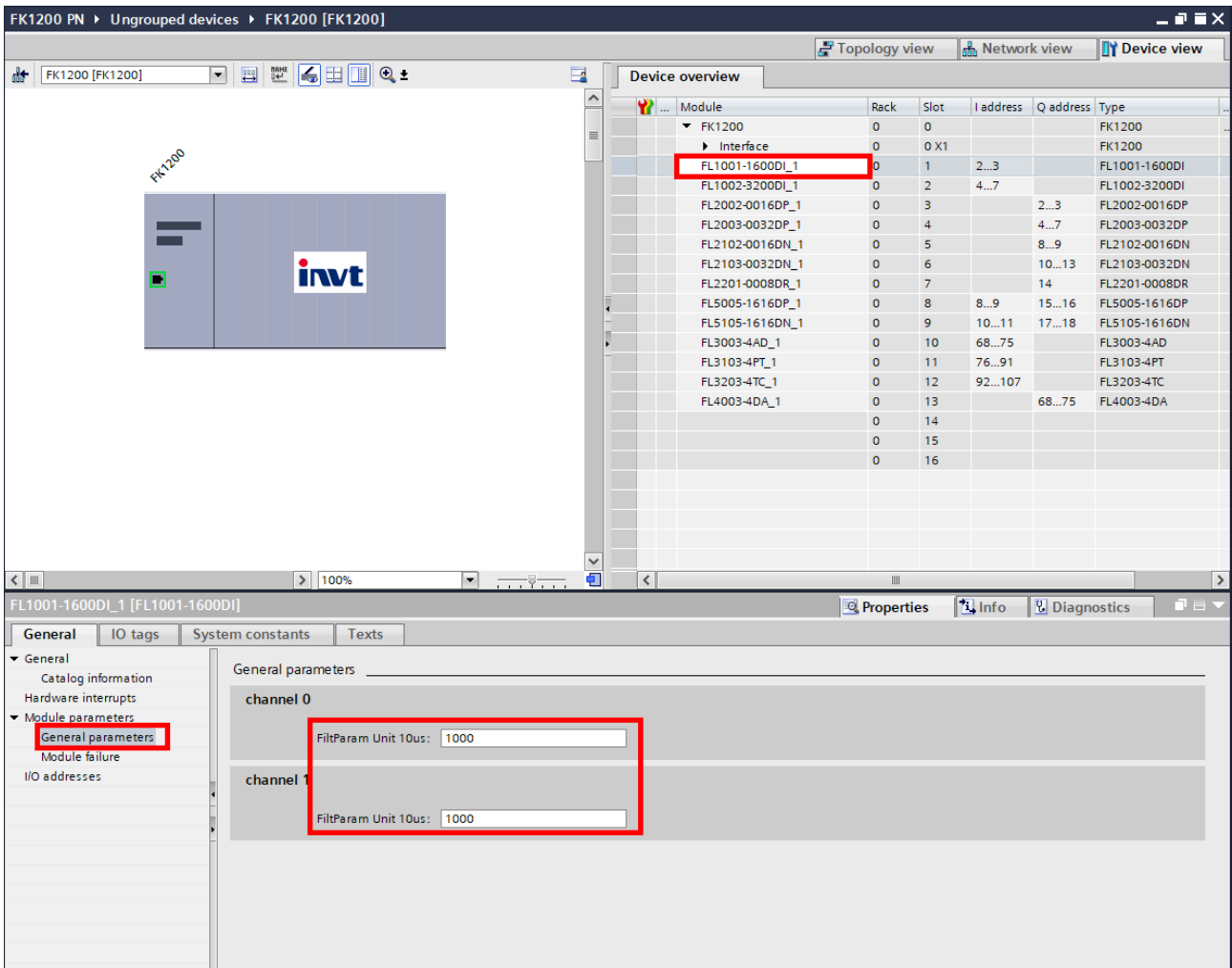

Step 5 After completing the network configuration, set all configuration module parameters. Once compiled, the program can be downloaded and run.

6.2 I/O module

6.2.1 FL1001 (1600D) digital input module

6.2.1.1 EtherCAT communication programming

1. Device import

Step 1 Add the FL1001-1600DI device.

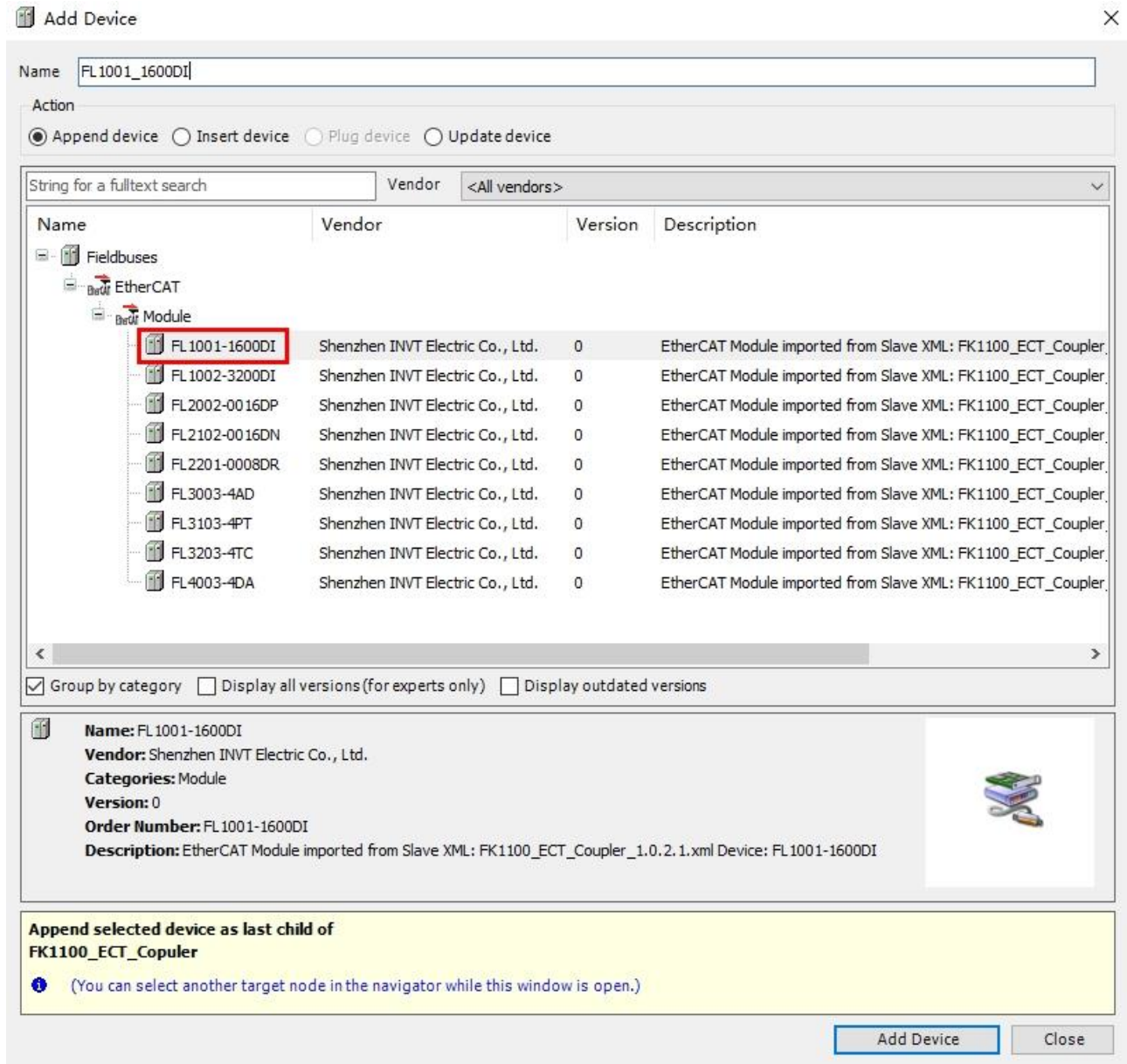

Step 2 Choose **Startup Parameters**, change the port filter mode based on the actual needs. Note that the unit is 10µs.

Line	Index/Subindex	Name	Value	Bit Length	Abort on Error	Jump to Line on Error	Next Line	Comment
1	16#8001:16#01	1600DI Fil0	1000	16	<input type="checkbox"/>	<input type="checkbox"/>	0	1600DI Fil0
2	16#8001:16#02	1600DI Fil1	1000	16	<input type="checkbox"/>	<input type="checkbox"/>	0	1600DI Fil1

Step 3 Define *ibButton1* and *ibButton2* of the BOOL type in the program.

```

VAR
  ibButton1      : BOOL;
  ibButton2      : BOOL;

END_VAR
    
```

Step 4 Choose **Module I/O Mapping**, map *ibButton1* and *ibButton2* to the corresponding input points. You just need to use mapped variables in the program.

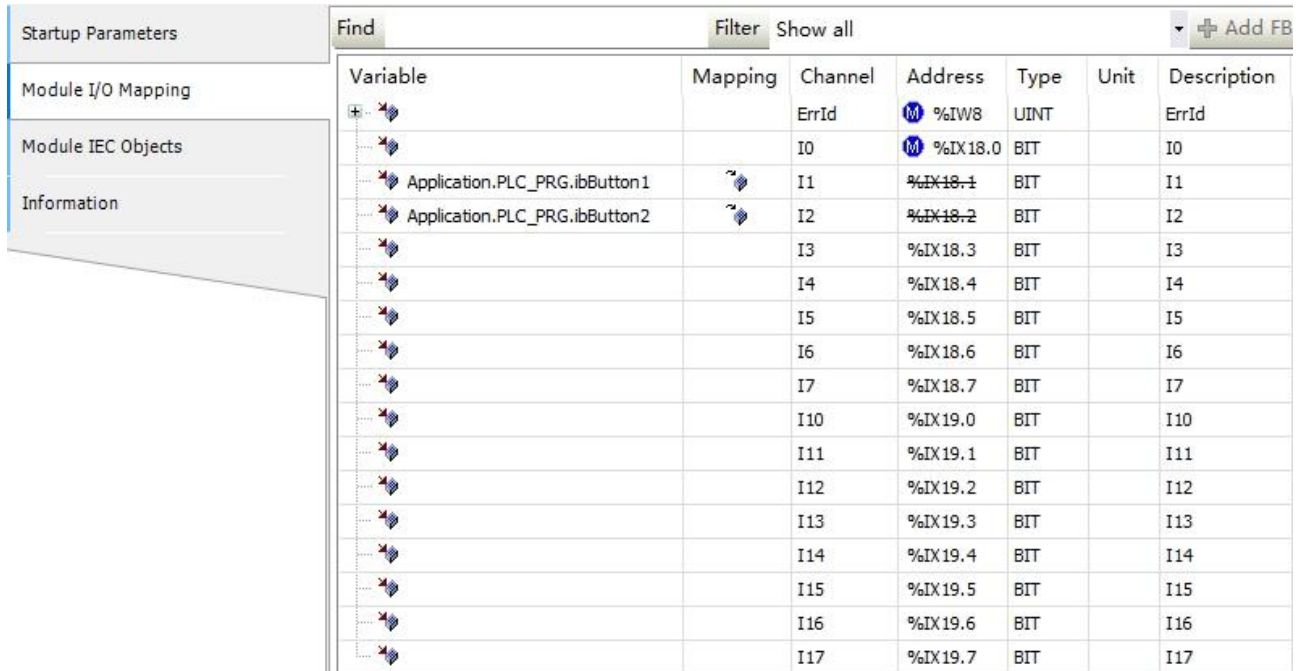

2. Parameter description

Parameter	Type	Description
Filt0	UINT	Filter parameters I0–I7. Unit: 10µs
Filt1	UINT	Filter parameters I10–I17. Unit: 10µs
ErrId	UINT	Fault ID
I0	BIT	I0 status feedback
I1	BIT	I1 status feedback
...
I17	BIT	I17 status feedback
Module Info. HW Version	UINT	Module hardware version number
Module Info. FPGA Version	UINT	Module FPGA software version number

6.2.1.2 PROFINET communication programming

Step 1 In the **Device view** interface, add **FL1001-1600DI**, double click **FL1001-1600DI** under **Module**, choose **Properties > General > Module parameters**, and then set module initialization parameters.

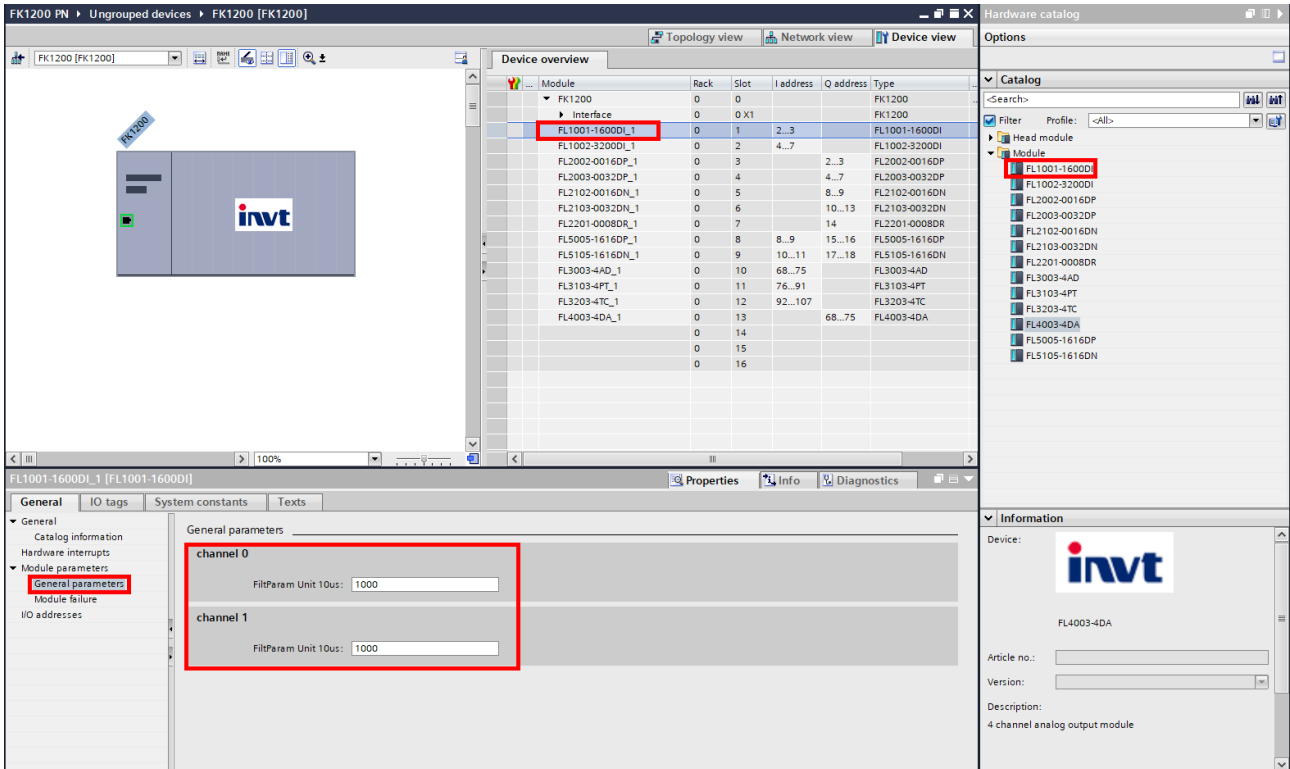

Step 2 Obtain sampling values through I addresses.

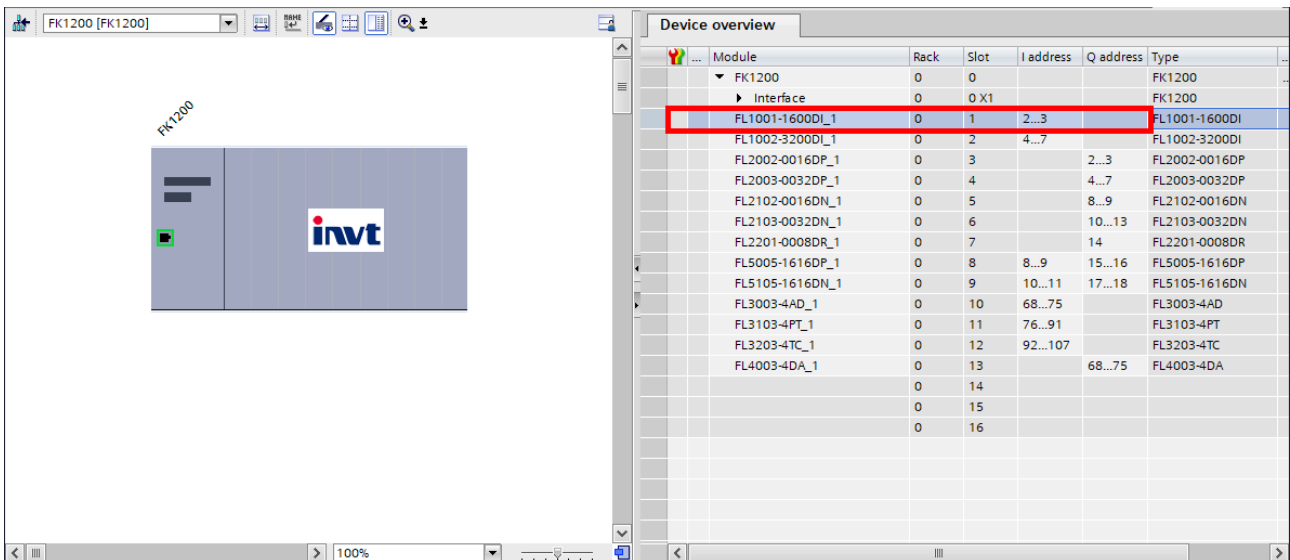

6.2.2 FL2002 (0016DP) digital output module (Source type)

6.2.2.1 EtherCAT communication programming

1. Device import

Step 1 Add the FL2002-0016DP device.

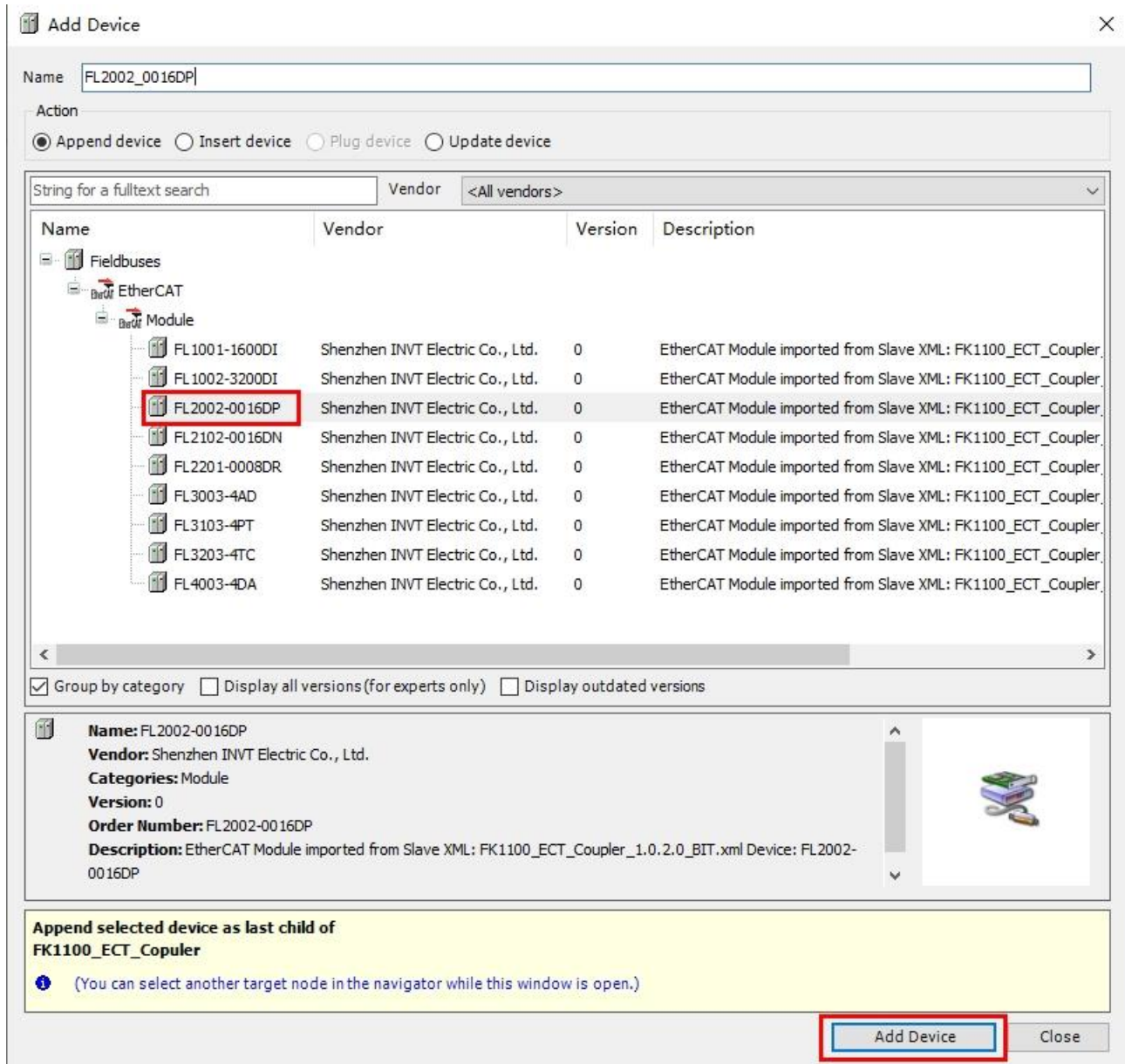

Step 2 Set the stop/offline output mode and preset value based on actual needs in the startup parameters.

Line	Index:Subindex	Name	Value	Bit Length	Abort on Error	Jump to Line on Error	Next Line	Comment
1	16#8005:16#01	0016DP Stop Mode0	0	16	<input type="checkbox"/>	<input type="checkbox"/>	0	0016DP Stop Mode0
2	16#8005:16#02	0016DP Stop Mode1	0	16	<input type="checkbox"/>	<input type="checkbox"/>	0	0016DP Stop Mode1
3	16#8005:16#03	0016DP Stop Output0	0	8	<input type="checkbox"/>	<input type="checkbox"/>	0	0016DP Stop Output0
4	16#8005:16#04	0016DP Stop Output1	0	8	<input type="checkbox"/>	<input type="checkbox"/>	0	0016DP Stop Output1

Step 3 Define *obCylinder1* and *obCylinder2* of the BOOL type in the program.

```

VAR
  obCylinder1   : BOOL;
  obCylinder2   : BOOL;

END_VAR
    
```

Step 4 Choose **Module I/O Mapping**, map *obCylinder1* and *obCylinder2* to the corresponding output points. You just need to use mapped variables in the program.

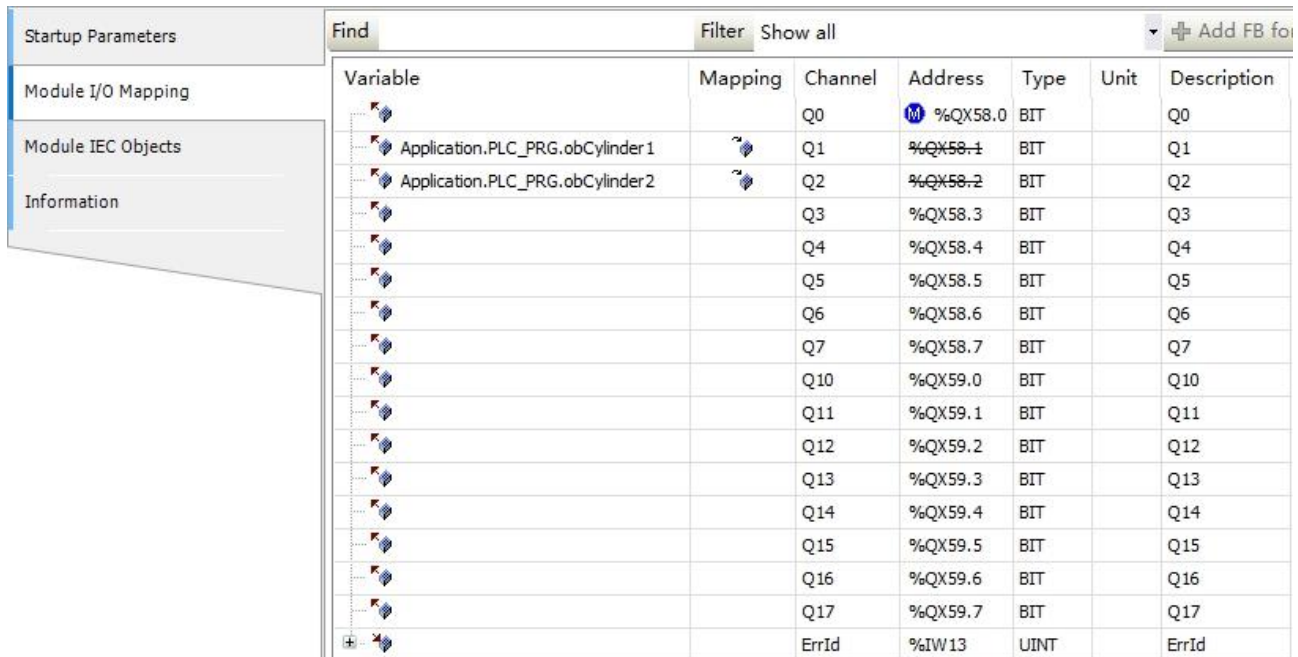

2. Parameter description

Parameter	Type	Description												
Stop Mode0	UINT	Stop/offline output mode: <table border="1"> <tr> <td>Q7</td> <td>...</td> <td>Q1</td> <td>Q0</td> </tr> <tr> <td>bit15</td> <td>bit14</td> <td>...</td> <td>...</td> <td>bit3</td> <td>bit2</td> <td>bit1</td> <td>bit0</td> </tr> </table> 0b00: Stop/offline output retained 0b01: Stop/offline output cleared 0b10: Stop/offline output according to the preset	Q7	...	Q1	Q0	bit15	bit14	bit3	bit2	bit1	bit0
Q7	...	Q1	Q0											
bit15	bit14	bit3	bit2	bit1	bit0							
Stop Mode1	UINT	Stop/offline output mode <table border="1"> <tr> <td>Q17</td> <td>...</td> <td>Q11</td> <td>Q10</td> </tr> <tr> <td>bit15</td> <td>bit14</td> <td>...</td> <td>...</td> <td>bit3</td> <td>bit2</td> <td>bit1</td> <td>bit0</td> </tr> </table> 0b00: Stop/offline output retained 0b01: Stop/offline output cleared 0b10: Stop/offline output according to the preset	Q17	...	Q11	Q10	bit15	bit14	bit3	bit2	bit1	bit0
Q17	...	Q11	Q10											
bit15	bit14	bit3	bit2	bit1	bit0							
Stop Output0	USINT	Preset value of stop/offline output: <table border="1"> <tr> <td>Q7</td> <td>...</td> <td>Q1</td> <td>Q0</td> </tr> <tr> <td>bit7</td> <td>...</td> <td>bit1</td> <td>bit0</td> </tr> </table>	Q7	...	Q1	Q0	bit7	...	bit1	bit0				
Q7	...	Q1	Q0											
bit7	...	bit1	bit0											
Stop Output1	USINT	Preset value of stop/offline output: <table border="1"> <tr> <td>Q17</td> <td>...</td> <td>Q11</td> <td>Q10</td> </tr> <tr> <td>bit7</td> <td>...</td> <td>bit1</td> <td>bit0</td> </tr> </table>	Q17	...	Q11	Q10	bit7	...	bit1	bit0				
Q17	...	Q11	Q10											
bit7	...	bit1	bit0											
Q0	BIT	Q0 output control												
Q1	BIT	Q1 output control												
...														

Parameter	Type	Description
Q17	BIT	Q17 output control
ErrId	UINT	Fault ID
Module Info. HW Version	UINT	Module hardware version number
Module Info. FPGA Version	UINT	Module FPGA software version number

6.2.2.2 PROFINET communication programming

Step 1 In the **Device view** interface, add **FL2002-0016DP**, double click **FL2002-0016DP** under **Module**, choose **Properties > General > Module parameters**, and then set module initialization parameters.

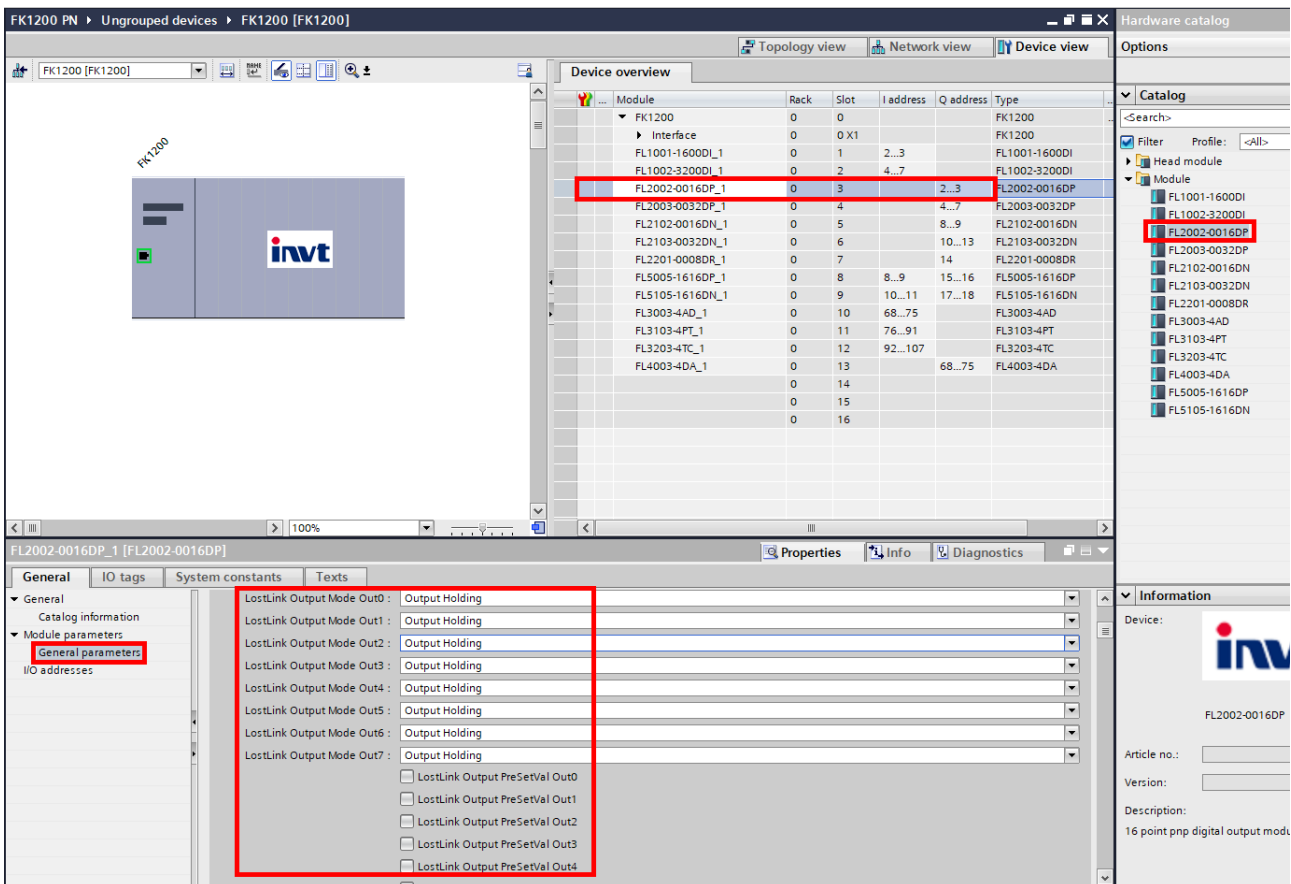

Step 2 Obtain sampling values through Q addresses.

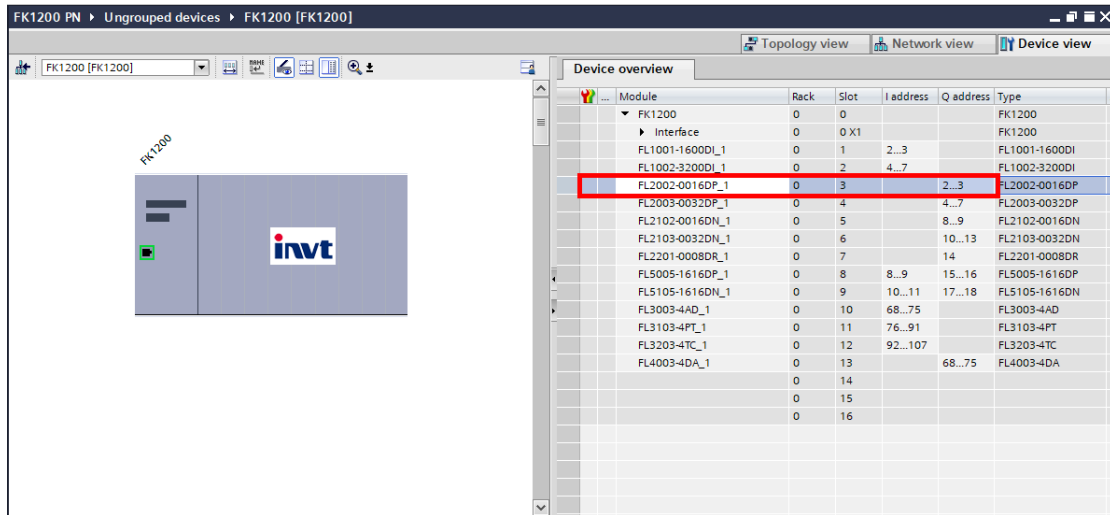

6.2.3 FL2102 (0016DN) digital output module (Sink type)

6.2.3.1 EtherCAT communication programming

1. Device import

Step 1 Add the FL2102-0016DN device.

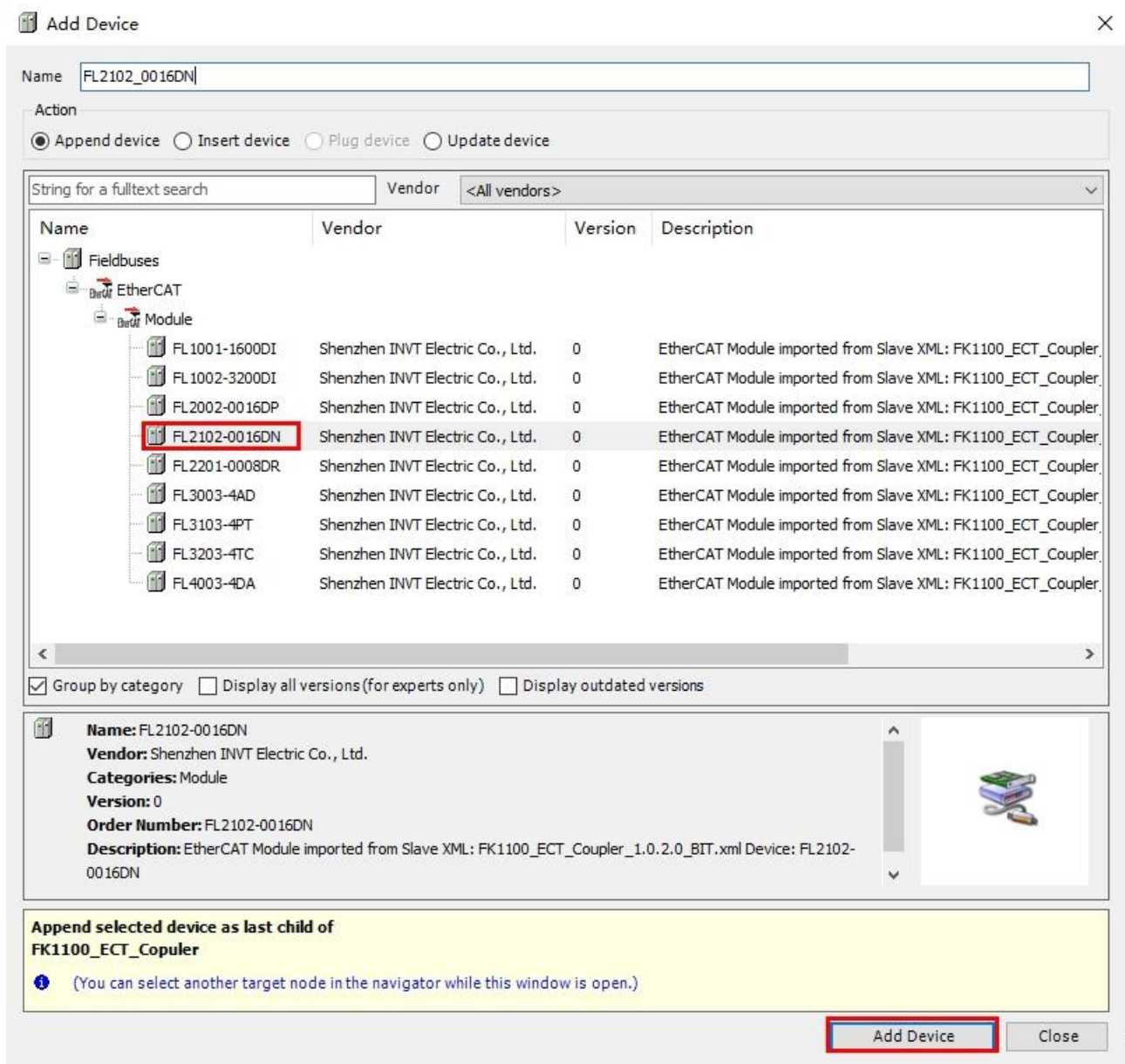

Step 2 Set the stop/offline output mode and preset value based on actual needs in the startup parameters.

Module I/O Mapping	Line	Index:Subindex	Name	Value	Bit Length	Abort on Error	Jump to Line on Error	Next Line	Comment
Module I/O Mapping	1	16#8005:16#01	0016DN Stop Mode0	0	16	<input type="checkbox"/>	<input type="checkbox"/>	0	0016DN Stop Mode0
Module IEC Objects	2	16#8005:16#02	0016DN Stop Mode1	0	16	<input type="checkbox"/>	<input type="checkbox"/>	0	0016DN Stop Mode1
Information	3	16#8005:16#03	0016DN Stop Output0	0	8	<input type="checkbox"/>	<input type="checkbox"/>	0	0016DN Stop Output0
	4	16#8005:16#04	0016DN Stop Output1	0	8	<input type="checkbox"/>	<input type="checkbox"/>	0	0016DN Stop Output1

Step 3 Define *obCylinder1* and *obCylinder2* of the BOOL type in the program.

```

VAR
obCylinder1   : BOOL;
obCylinder2   : BOOL;

END_VAR
    
```

Step 4 Choose **Module I/O Mapping**, map *obCylinder1* and *obCylinder2* to the corresponding output points. You just need to use mapped variables in the program.

Variable	Mapping	Channel	Address	Type	Unit	Description
		Q0	%QX58.0	BIT		Q0
Application.PLC_PRG.obCylinder 1		Q1	%QX58.1	BIT		Q1
Application.PLC_PRG.obCylinder 2		Q2	%QX58.2	BIT		Q2
		Q3	%QX58.3	BIT		Q3
		Q4	%QX58.4	BIT		Q4
		Q5	%QX58.5	BIT		Q5
		Q6	%QX58.6	BIT		Q6
		Q7	%QX58.7	BIT		Q7
		Q10	%QX59.0	BIT		Q10
		Q11	%QX59.1	BIT		Q11
		Q12	%QX59.2	BIT		Q12
		Q13	%QX59.3	BIT		Q13
		Q14	%QX59.4	BIT		Q14
		Q15	%QX59.5	BIT		Q15
		Q16	%QX59.6	BIT		Q16
		Q17	%QX59.7	BIT		Q17
		ErrId	%IW13	UINT		ErrId

2. Parameter description

Parameter	Type	Description												
Stop Mode0	UINT	Stop/offline output mode: <table border="1" style="margin-left: 20px;"> <tr> <td>Q7</td> <td>...</td> <td>Q1</td> <td>Q0</td> </tr> <tr> <td>bit15</td> <td>bit14</td> <td>...</td> <td>...</td> <td>bit3</td> <td>bit2</td> <td>bit1</td> <td>bit0</td> </tr> </table> 0b00: Stop/offline output retained 0b01: Stop/offline output cleared 0b10: Stop/offline output according to the preset	Q7	...	Q1	Q0	bit15	bit14	bit3	bit2	bit1	bit0
Q7	...	Q1	Q0											
bit15	bit14	bit3	bit2	bit1	bit0							
Stop Mode1	UINT	Stop/offline output mode: <table border="1" style="margin-left: 20px;"> <tr> <td>Q17</td> <td>...</td> <td>Q11</td> <td>Q10</td> </tr> <tr> <td>bit15</td> <td>bit14</td> <td>...</td> <td>...</td> <td>bit3</td> <td>bit2</td> <td>bit1</td> <td>bit0</td> </tr> </table> 0b00: Stop/offline output retained 0b01: Stop/offline output cleared 0b10: Stop/offline output according to the preset	Q17	...	Q11	Q10	bit15	bit14	bit3	bit2	bit1	bit0
Q17	...	Q11	Q10											
bit15	bit14	bit3	bit2	bit1	bit0							
Stop Output0	USINT	Preset value of stop/offline output: <table border="1" style="margin-left: 20px;"> <tr> <td>Q7</td> <td>...</td> <td>Q1</td> <td>Q0</td> </tr> <tr> <td>bit7</td> <td>...</td> <td>bit1</td> <td>bit0</td> </tr> </table>	Q7	...	Q1	Q0	bit7	...	bit1	bit0				
Q7	...	Q1	Q0											
bit7	...	bit1	bit0											
Stop Output1	USINT	Preset value of stop/offline output: <table border="1" style="margin-left: 20px;"> <tr> <td>Q17</td> <td>...</td> <td>Q11</td> <td>Q10</td> </tr> <tr> <td>bit7</td> <td>...</td> <td>bit1</td> <td>bit0</td> </tr> </table>	Q17	...	Q11	Q10	bit7	...	bit1	bit0				
Q17	...	Q11	Q10											
bit7	...	bit1	bit0											
Q0	BIT	Q0 output control												
Q1	BIT	Q1 output control												
...														
Q17	BIT	Q17 output control												
ErrId	UINT	Fault ID												
Module Info.HW Version	UINT	Module hardware version number												
Module Info.FPGA Version	UINT	Module FPGA software version number												

6.2.3.2 PROFINET communication programming

Step 1 In the **Device view** interface, add **FL2102-0016DN**, double click **FL2102-0016DN** under **Module**, choose **Properties > General > Module parameters**, and then set module initialization parameters.

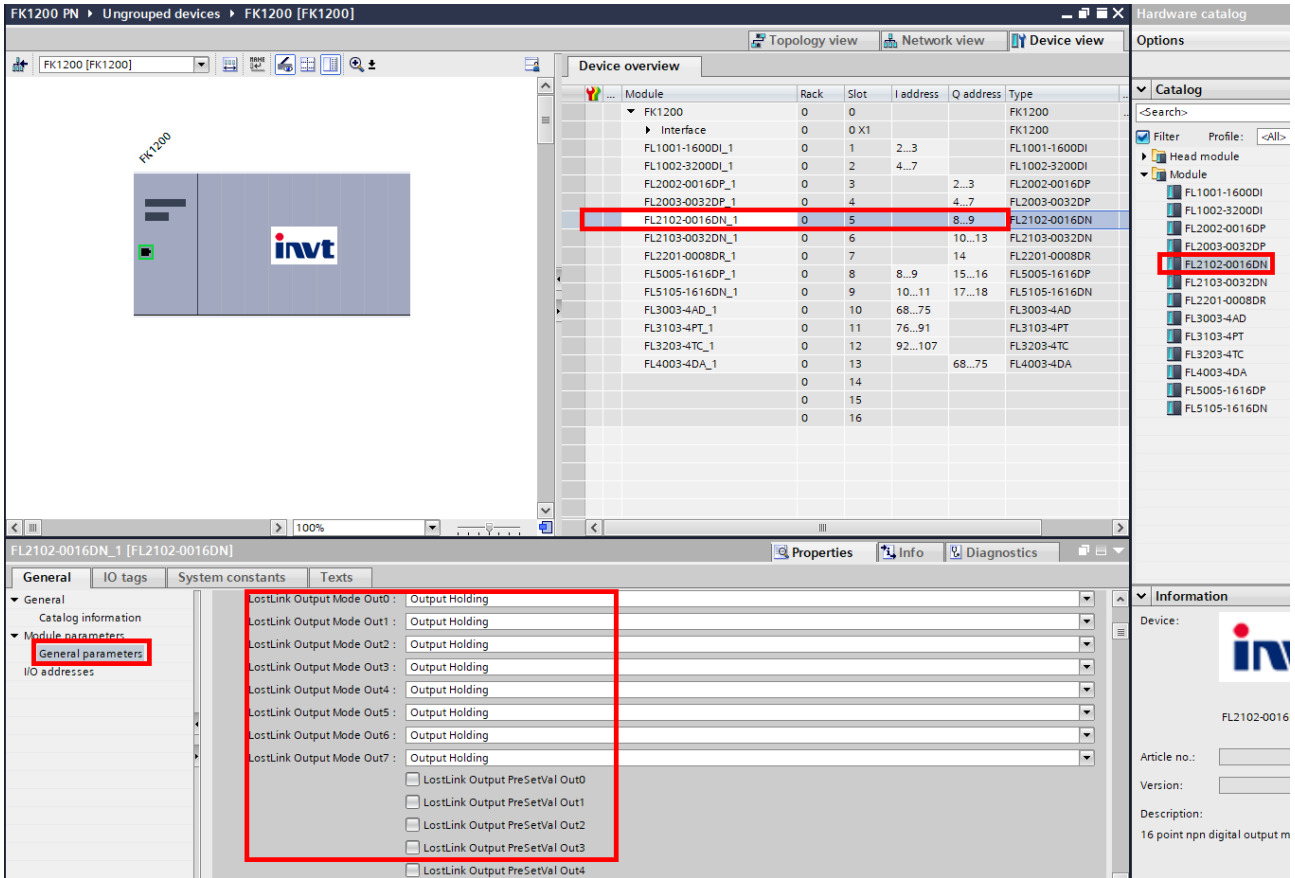

Step 2 Obtain sampling values through Q addresses.

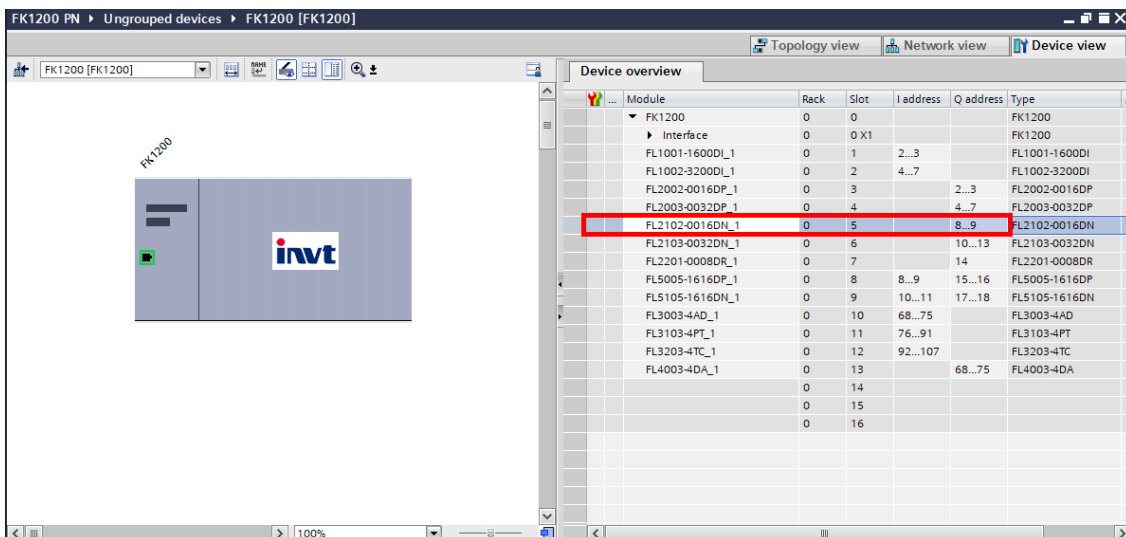

6.2.4 FL2201 (0008DR) digital output module (Relay)

6.2.4.1 EtherCAT communication programming

1. Device import

Step 1 Add the FL2201-0008DR device.

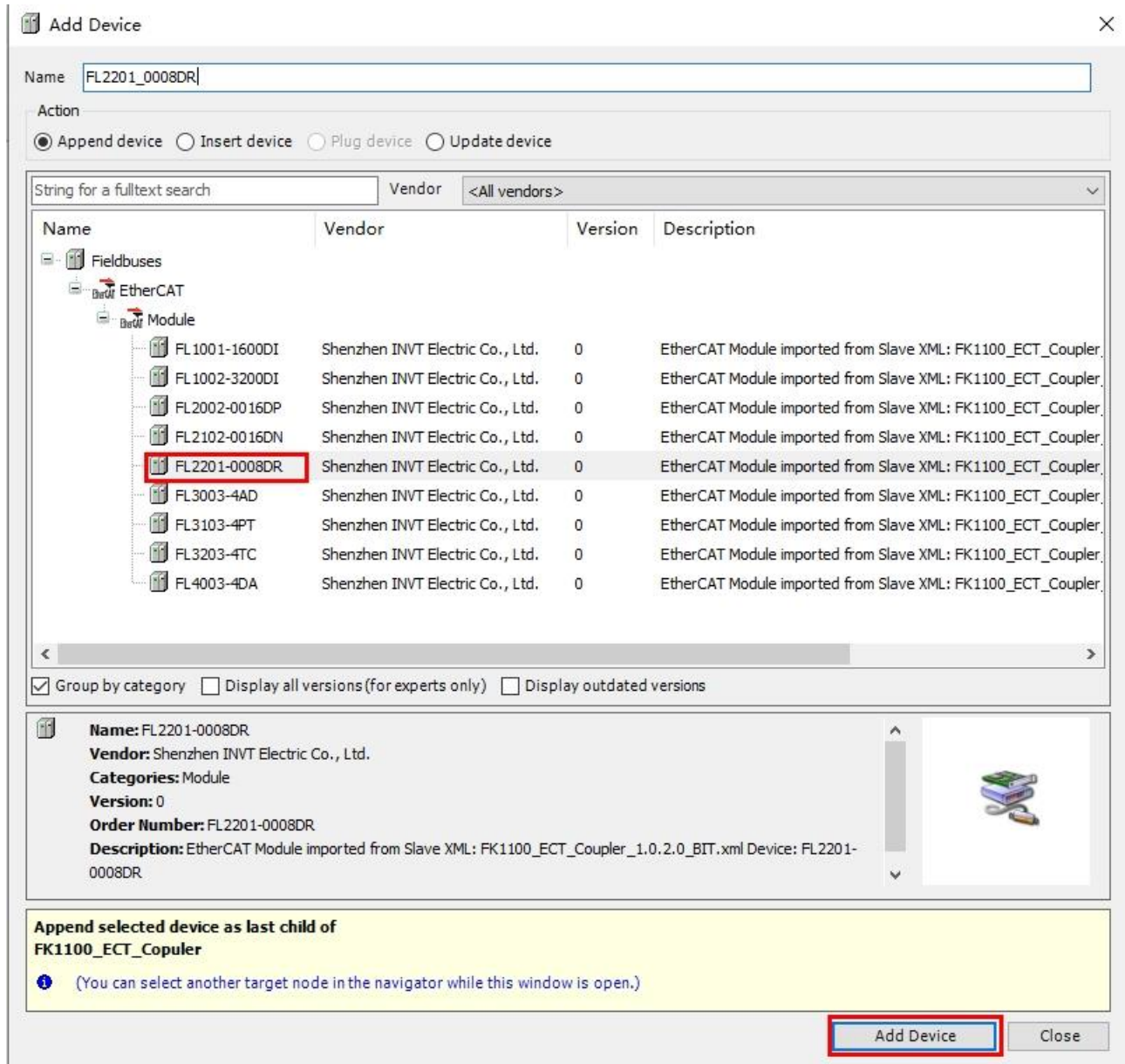

Step 2 Set the stop/offline output mode and preset value based on actual needs in the startup parameters.

Line	Index:Subindex	Name	Value	Bit Length	Abort on Error	Jump to Line on Error	Next Line	Comment
1	16#8004:16#01	0008DR Stop Mode	0	16	<input type="checkbox"/>	<input type="checkbox"/>	0	0008DR Stop Mode
2	16#8004:16#02	0008DR Stop Output	0	8	<input type="checkbox"/>	<input type="checkbox"/>	0	0008DR Stop Output

Step 3 Define *obCylinder1* and *obCylinder2* of the BOOL type in the program.

```

VAR
  obCylinder1 : BOOL;
  obCylinder2 : BOOL;

END_VAR
    
```

Step 4 Choose **Module I/O Mapping**, map *obCylinder1* and *obCylinder2* to the corresponding output points. You just need to use mapped variables in the program.

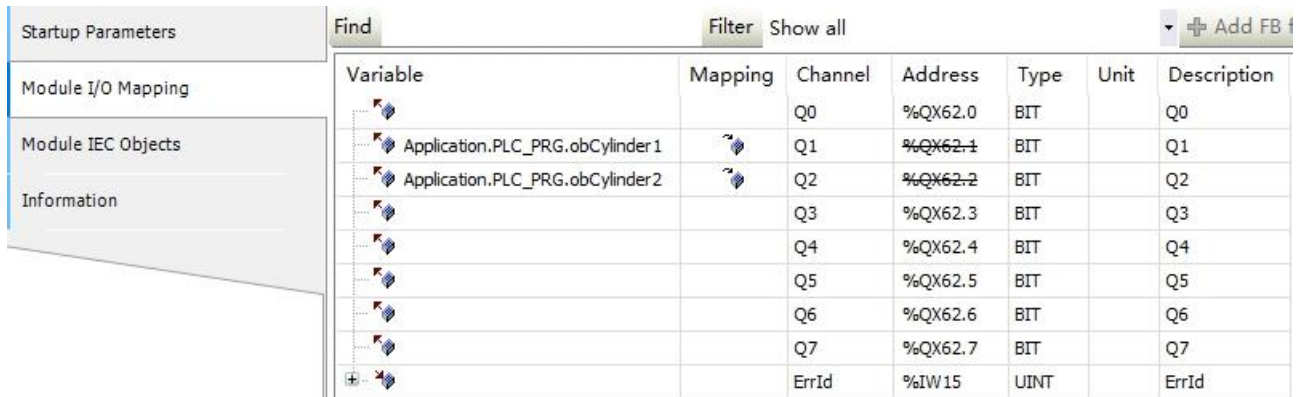

2. Parameter description

Parameter	Type	Description														
Stop Mode	UINT	Stop/offline output mode:														
		<table border="1"> <tr> <td>Q7</td> <td>...</td> <td>Q1</td> <td>Q0</td> </tr> <tr> <td>bit15</td> <td>bit14</td> <td>...</td> <td>...</td> </tr> <tr> <td></td> <td></td> <td>bit3</td> <td>bit2</td> </tr> <tr> <td></td> <td></td> <td>bit1</td> <td>bit0</td> </tr> </table>	Q7	...	Q1	Q0	bit15	bit14			bit3	bit2		
Q7	...	Q1	Q0													
bit15	bit14													
		bit3	bit2													
		bit1	bit0													
Stop Output	USINT	0b00: Stop/offline output retained														
		0b01: Stop/offline output cleared														
		0b01: Stop/offline output according to the preset														
		Preset value of stop/offline output:														
		<table border="1"> <tr> <td>Q7</td> <td>...</td> <td>Q1</td> <td>Q0</td> </tr> <tr> <td>bit7</td> <td>...</td> <td>bit1</td> <td>bit0</td> </tr> </table>	Q7	...	Q1	Q0	bit7	...	bit1	bit0						
Q7	...	Q1	Q0													
bit7	...	bit1	bit0													
Q0	BIT	Q0 output control														
Q1–	BIT	Q1 output control														
...																
Q7	BIT	Q7 output control														
ErrId	UINT	Fault ID														
HW Version	UINT	Module hardware version number														
FPGA Version	UINT	Module FPGA software version number														

6.2.4.2 PROFINET communication programming

Step 1 In the **Device view** interface, add **FL2201-0008DR**, double click **FL2201-0008DR** under **Module**, choose **Properties > General > Module parameters**, and then set module initialization parameters.

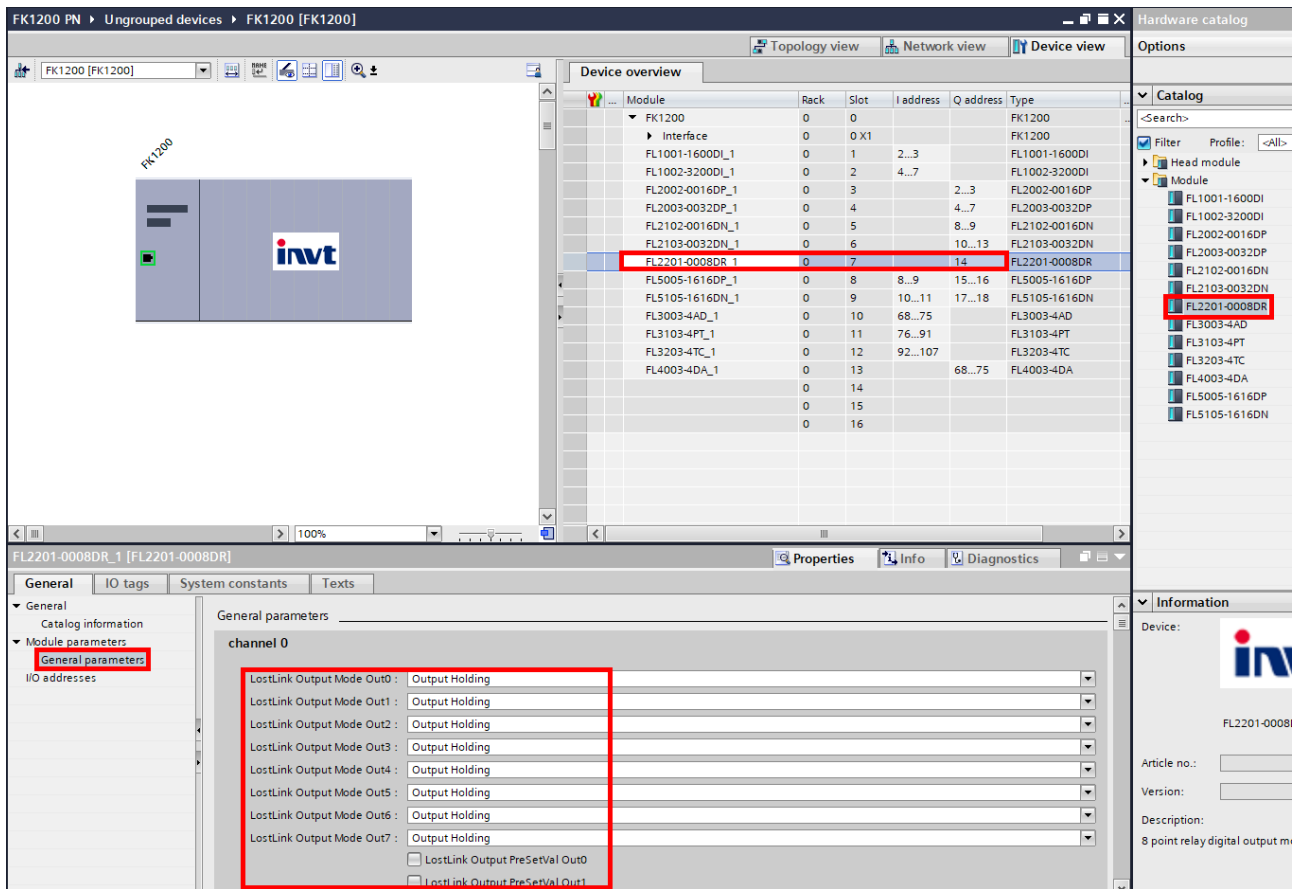

Step 2 Obtain sampling values through Q addresses.

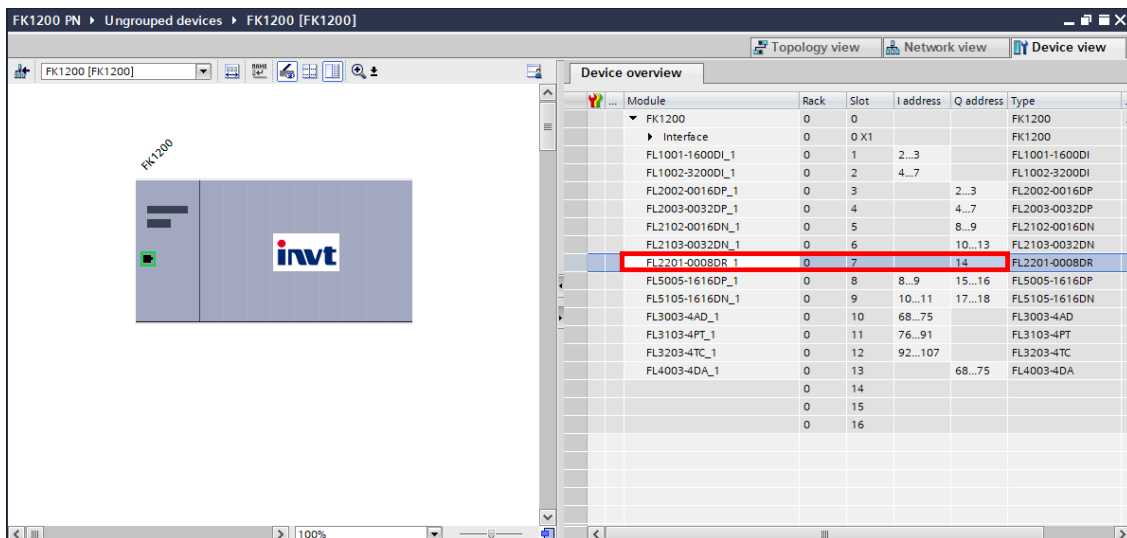

6.2.5 FL3003 (4AD) analog input module

6.2.5.1 EtherCAT communication programming

1. Device import

Step 1 Add the FL3003-4AD device.

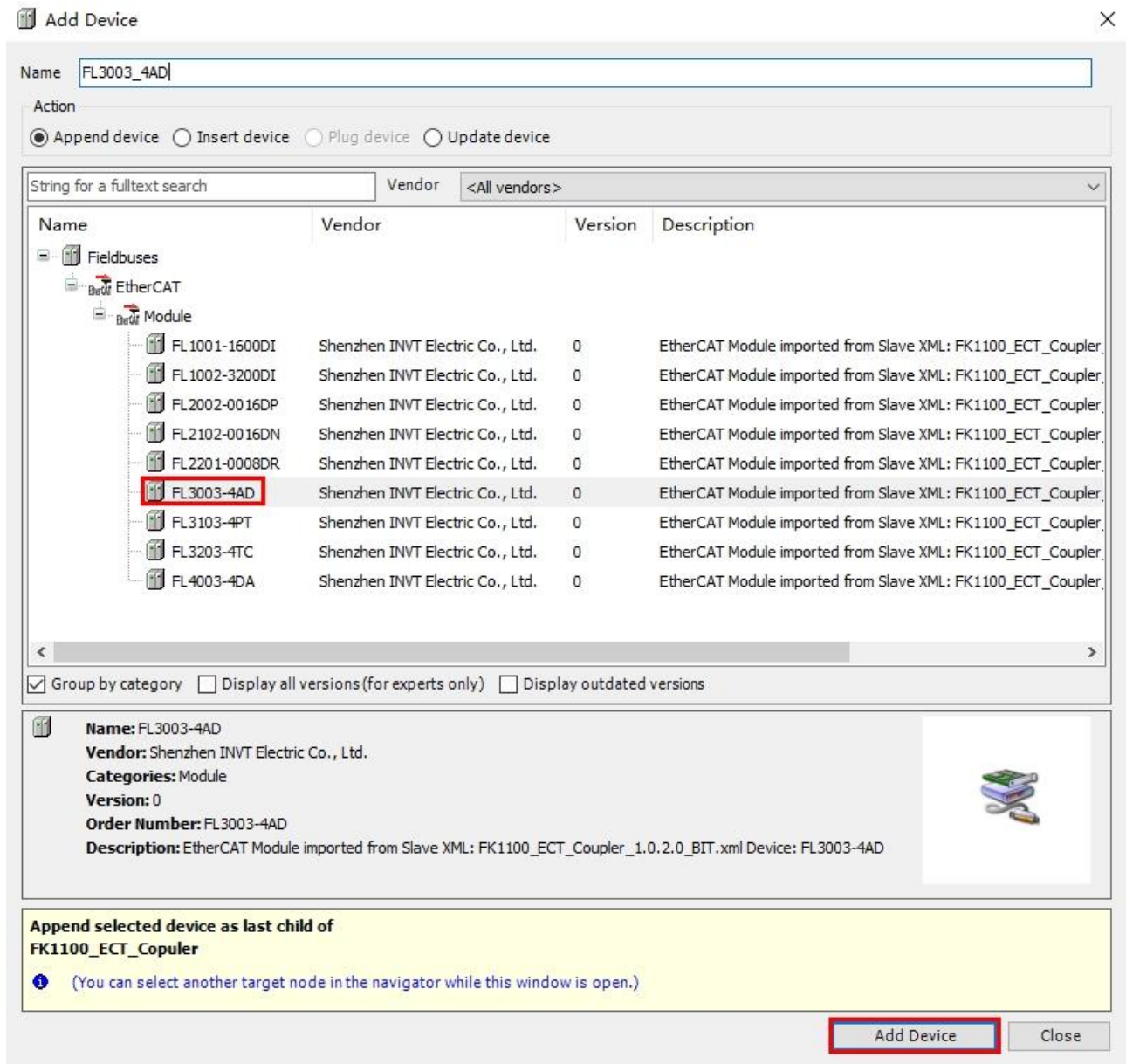

Step 2 Set the channel configuration and channel filter parameters based on actual needs in the startup parameters.

Line	Index/Subindex	Name	Value	Bit Length	Abort on Error	Jump to Line on Error	Next Line	Comment
1	16#8015:16#01	4AD AI0 Cfg	1	8	<input type="checkbox"/>	<input type="checkbox"/>	0	4AD AI0 Cfg
2	16#8015:16#02	4AD AI1 Cfg	1	8	<input type="checkbox"/>	<input type="checkbox"/>	0	4AD AI1 Cfg
3	16#8015:16#03	4AD AI2 Cfg	1	8	<input type="checkbox"/>	<input type="checkbox"/>	0	4AD AI2 Cfg
4	16#8015:16#04	4AD AI3 Cfg	1	8	<input type="checkbox"/>	<input type="checkbox"/>	0	4AD AI3 Cfg
5	16#8015:16#05	4AD AI0 Filtr	8	8	<input type="checkbox"/>	<input type="checkbox"/>	0	4AD AI0 Filtr
6	16#8015:16#06	4AD AI1 Filtr	8	8	<input type="checkbox"/>	<input type="checkbox"/>	0	4AD AI1 Filtr
7	16#8015:16#07	4AD AI2 Filtr	8	8	<input type="checkbox"/>	<input type="checkbox"/>	0	4AD AI2 Filtr
8	16#8015:16#08	4AD AI3 Filtr	8	8	<input type="checkbox"/>	<input type="checkbox"/>	0	4AD AI3 Filtr

Step 3 Define *iValueAD0* and *iValueAD1* of the INT type in the program.

```

VAR
  iValueAD0    : INT;
  iValueAD1    : INT;

END_VAR
    
```

Step 4 Choose **Module I/O Mapping**, map *iValueAD0* and *iValueAD1* to the corresponding input channels. You just need to use mapped variables in the program.

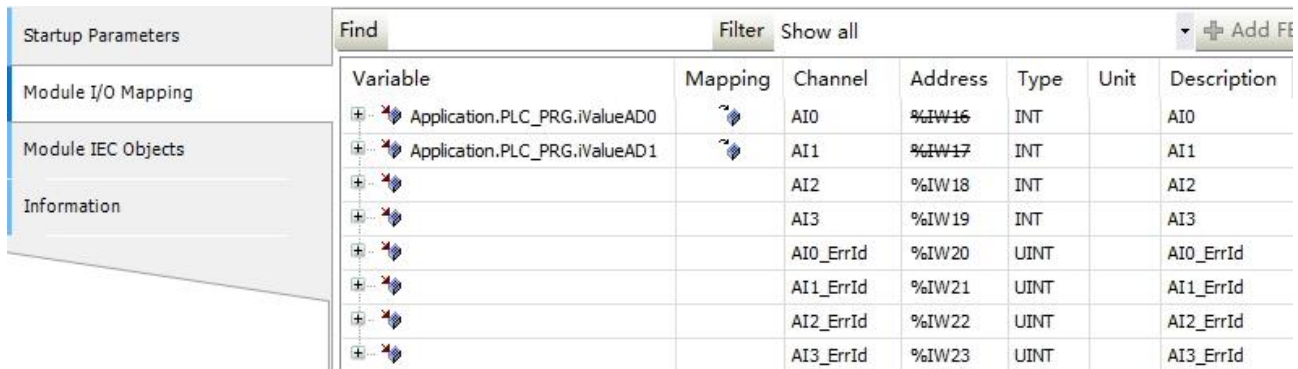

2. Parameter description

Name	Type	Description
A10 Cfg	USINT	Configuration parameter for channel 0. bit0: Channel enabling control. (0: Disable. 1: Enable.) bit1: Open-loop detection enabling control. (0: Disable. 1: Enable.) bit2: Over-limit detection enabling control. (0: Disable. 1: Enable.) bit3: Over-range detection enabling control. (0: Disable. 1: Enable.) bit4: Enhanced filter enabling control. (0: Disable. 1: Enable.) bit7–bit5: Channel conversion mode. (0b000: Voltage range 0–5V, corresponding to detection value range 0–20000 0b001: Voltage range 0–10V, corresponding to detection value range 0–20000 0b010: Voltage range -5–5V, corresponding to detection value range -20000–20000 0b011: Voltage range -10–10V, corresponding to detection value range -20000–20000 0b100: Current range 4–20mA, corresponding to detection value range 0–20000 0b101: Current range 0–20mA, corresponding to detection value range 0–20000 0b110: Reserved 0b111: Current range -20–20mA, corresponding to detection value range -20000–20000)
A11 Cfg	USINT	Configuration parameter for channel 1. The parameter setting is consistent with that for channel 0.
A12 Cfg	USINT	Configuration parameter for channel 2. The parameter setting is

Name	Type	Description
		consistent with that for channel 0.
AI3 Cfg	USINT	Configuration parameter for channel 3. The parameter setting is consistent with that for channel 0.
AI0 Filt	USINT	Filter parameter for channel 0. Range: 1–255. A greater value indicates better filter effect but greater lagging.
AI1 Filt	USINT	Filter parameter for channel 1. The filter parameter setting is consistent with that for channel 0.
AI2 Filt	USINT	Filter parameter for channel 2. The filter parameter setting is consistent with that for channel 0.
AI3 Filt	USINT	Filter parameter for channel 3. The filter parameter setting is consistent with that for channel 0.
AI0	INT	Conversion value for channel 0.
AI1	INT	Conversion value for channel 1.
AI2	INT	Conversion value for channel 2.
AI3	INT	Conversion value for channel 3.
AI0_Errld	UINT	Fault code for channel 0.
AI1_Errld	UINT	Fault code for channel 1.
AI2_Errld	UINT	Fault code for channel 2.
AI3_Errld	UINT	Fault code for channel 3.
HW Version	UINT	Module hardware version number
FPGA Version	UINT	Module FPGA software version number

6.2.5.2 PROFINET communication programming

Step 1 In the **Device view** interface, add **FL3003-4AD**, double click **FL3003-4AD** under **Module**, choose **Properties > General > Module parameters**, and then set module initialization parameters.

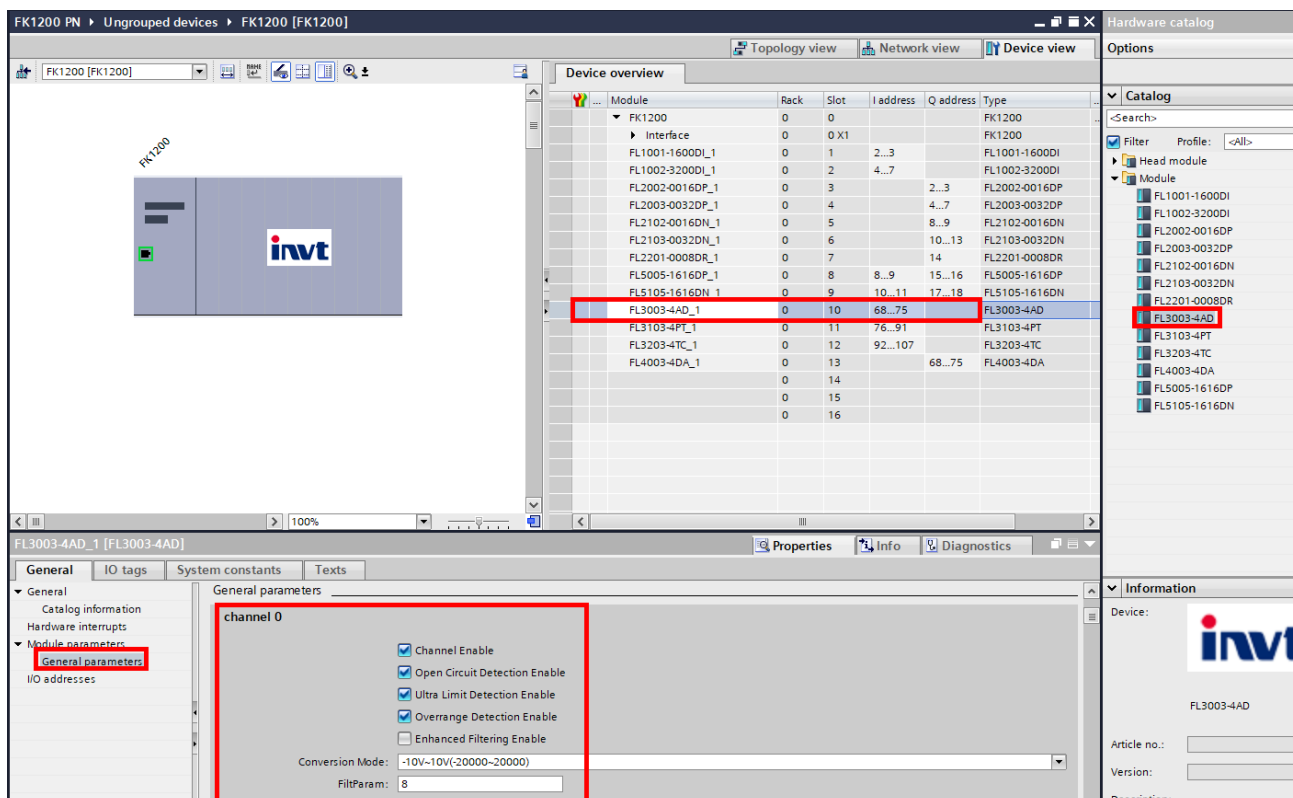

Step 2 Obtain sampling values through I addresses.

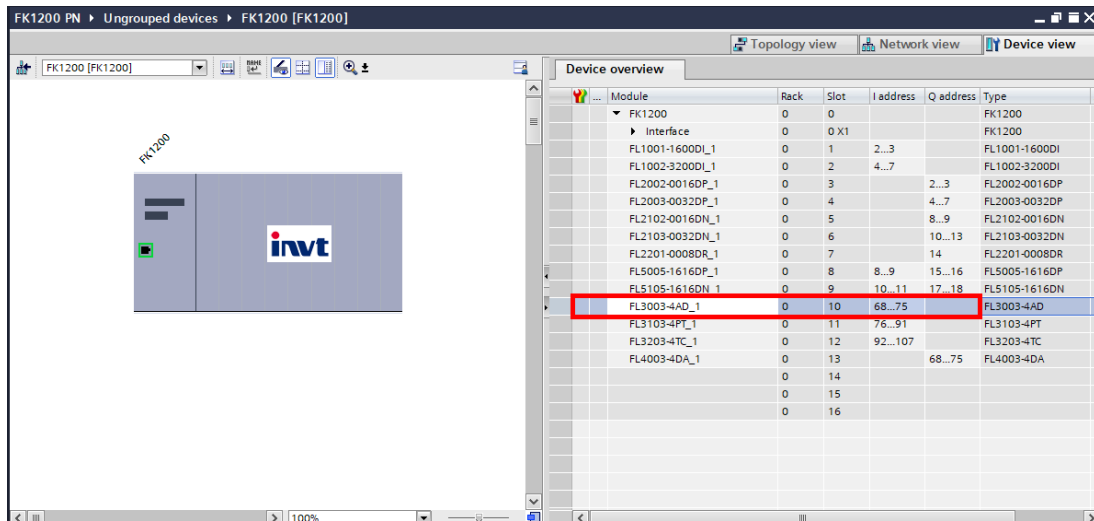

6.2.6 FL4003 (4DA) analog output module

6.2.6.1 EtherCAT communication programming

1. Device import

Step 1 Add the FL4003-4DA device.

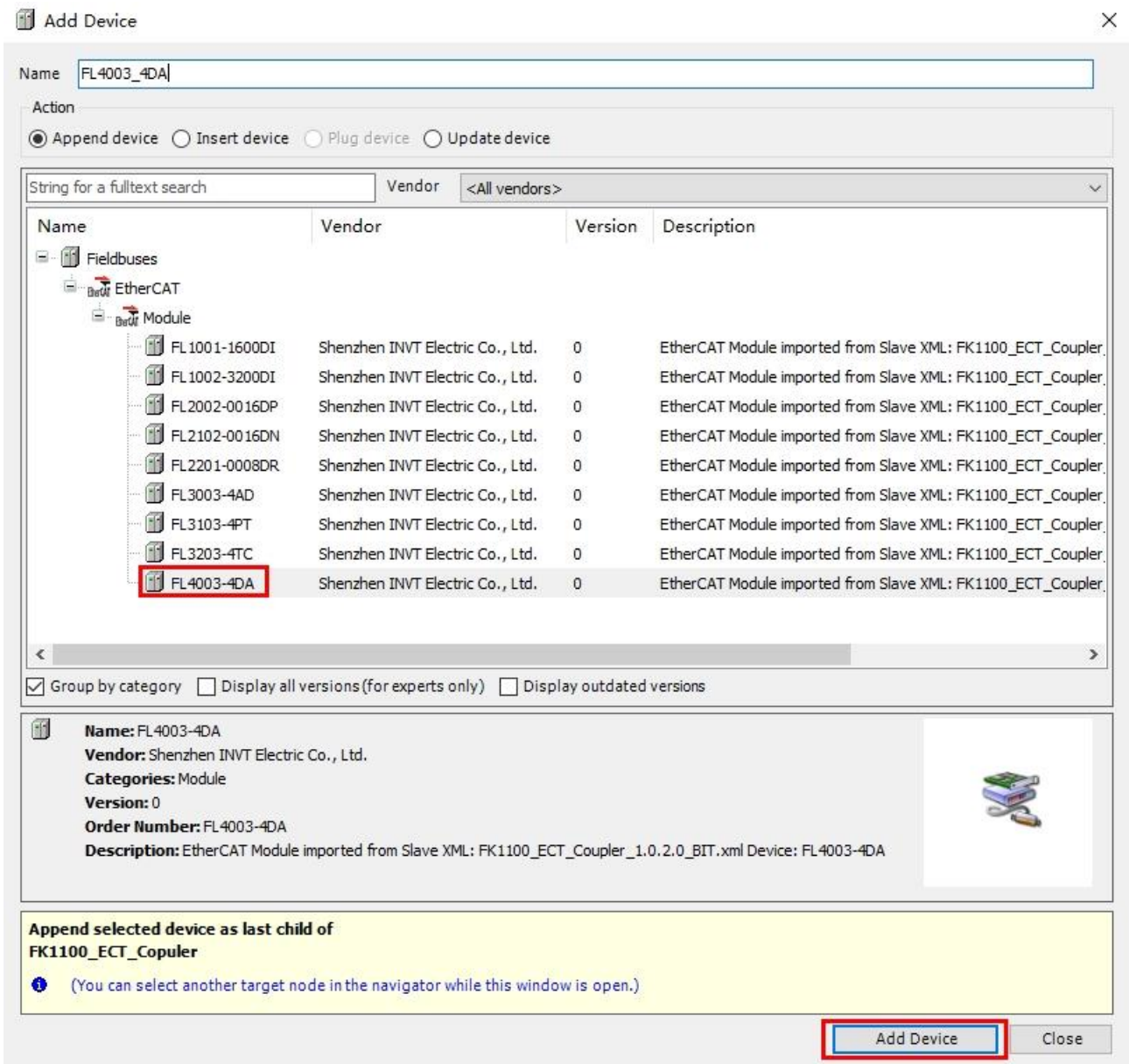

Step 2 Set the channel configuration and stop/offline output mode preset value parameters based on actual needs in the startup parameters.

Line	Index:Subindex	Name	Value	Bit Length	Abort on Error	Jump to Line on Error	Next Line	Comment
1	16#8019:16#01	4DA AO0 Cfg	0	8	<input type="checkbox"/>	<input type="checkbox"/>	0	4DA AO0 Cfg
2	16#8019:16#02	4DA AO1 Cfg	0	8	<input type="checkbox"/>	<input type="checkbox"/>	0	4DA AO1 Cfg
3	16#8019:16#03	4DA AO2 Cfg	0	8	<input type="checkbox"/>	<input type="checkbox"/>	0	4DA AO2 Cfg
4	16#8019:16#04	4DA AO3 Cfg	0	8	<input type="checkbox"/>	<input type="checkbox"/>	0	4DA AO3 Cfg
5	16#8019:16#05	4DA AO0 Stop Output	0	16	<input type="checkbox"/>	<input type="checkbox"/>	0	4DA AO0 Stop Output
6	16#8019:16#06	4DA AO1 Stop Output	0	16	<input type="checkbox"/>	<input type="checkbox"/>	0	4DA AO1 Stop Output
7	16#8019:16#07	4DA AO2 Stop Output	0	16	<input type="checkbox"/>	<input type="checkbox"/>	0	4DA AO2 Stop Output
8	16#8019:16#08	4DA AO3 Stop Output	0	16	<input type="checkbox"/>	<input type="checkbox"/>	0	4DA AO3 Stop Output

Step 3 Define *iValueDA0* and *iValueDA1* of the INT type in the program.

```

VAR
iValueDA0      : INT;
iValueDA1      : INT;

END_VAR
    
```

Step 4 Choose **Module I/O Mapping**, map *iValueDA0* and *iValueDA1* to the corresponding output channels. You just need to use mapped variables in the program.

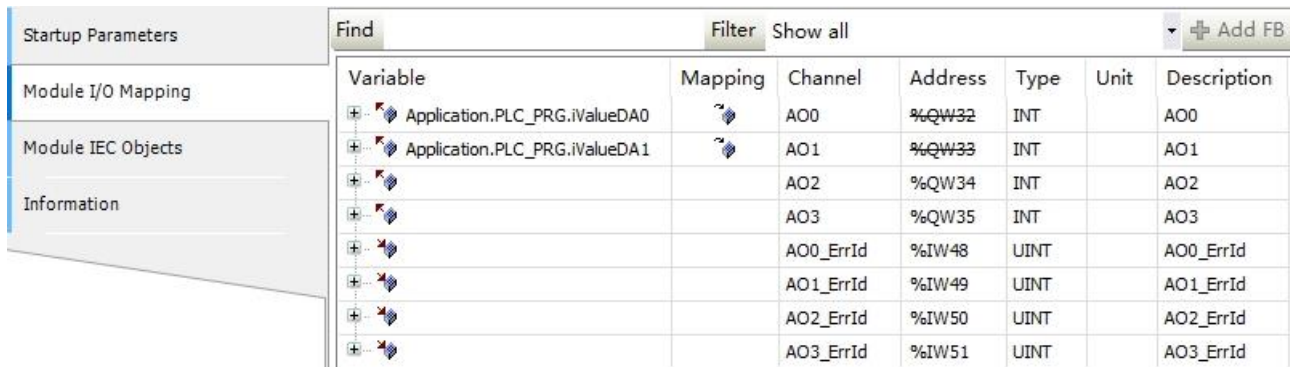

2. Parameter description

Name	Type	Description
AO0 Cfg	USINT	Configuration parameter for channel 0. bit0: Channel enabling control. (0: Disable. 1: Enable.) 1: Enable. bit1: Output fault detection enabling control. (0: Disable. 1: Enable.) bit3–bit2: Offline output mode. (0b00: Offline output retained 0b01: Offline output cleared 0b10: Offline output according to the preset) bit4: Reserved bit7–bit5: Channel conversion mode. (0b000: Voltage range 0–5V, corresponding to detection value range 0–20000 0b001: Voltage range 0–10V, corresponding to detection value range 0–20000 0b010: Voltage range -5–5V, corresponding to detection value range -20000–20000 0b011: Voltage range -10–10V, corresponding to detection value range -20000–20000 0b100: Current range 4–20mA, corresponding to detection value range 0–20000 0b101: Current range 0–20mA, corresponding to detection value range 0–20000 0b110: Reserved 0b111: Reserved)
AO1 Cfg	USINT	Configuration parameter for channel 1. The parameter setting is consistent with that for channel 0.
AO2 Cfg	USINT	Configuration parameter for channel 2. The parameter setting is consistent with that for channel 0.
AO3 Cfg	USINT	Configuration parameter for channel 3. The parameter setting is consistent with that for channel 0.
AO0 Stop Output	INT	Preset value of stop/offline output for channel 0.
AO1 Stop Output	INT	Preset value of stop/offline output for channel 1.
AO2 Stop Output	INT	Preset value of stop/offline output for channel 2.
AO3 Stop Output	INT	Preset value of stop/offline output for channel 3.
AO0	INT	Output control value for channel 0.

Name	Type	Description
AO1	INT	Output control value for channel 1.
AO2	INT	Output control value for channel 2.
AO3	INT	Output control value for channel 3.
AO0_ErrId	UINT	Fault code for channel 0.
AO1_ErrId	UINT	Fault code for channel 1.
AO2_ErrId	UINT	Fault code for channel 2.
AO3_ErrId	UINT	Fault code for channel 3.
HW Version	UINT	Module hardware version number
FPGA Version	UINT	Module FPGA software version number

6.2.6.2 PROFINET communication programming

Step 1 In the **Device view** interface, add **FL4003-4DA**, double click **FL4003-4DA** under **Module**, choose **Properties > General > Module parameters**, and then set module initialization parameters.

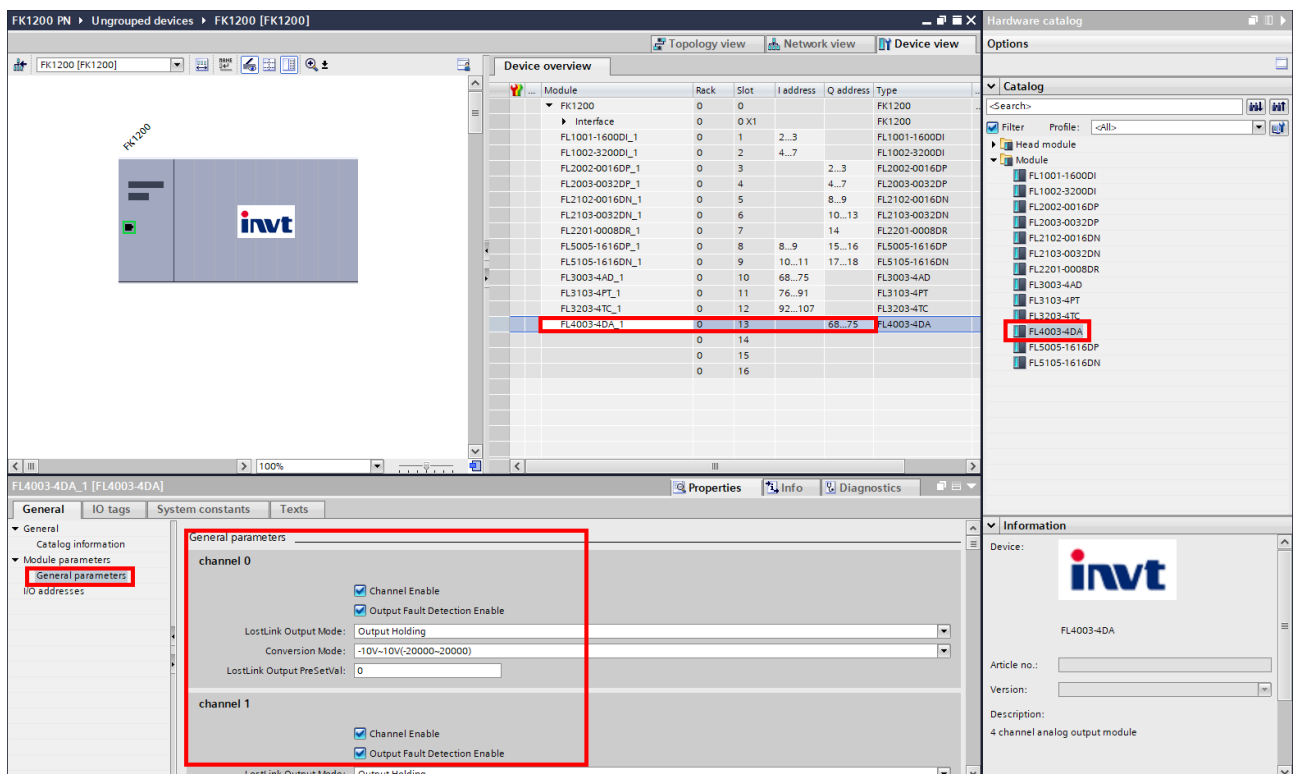

Step 2 Obtain sampling values through Q addresses.

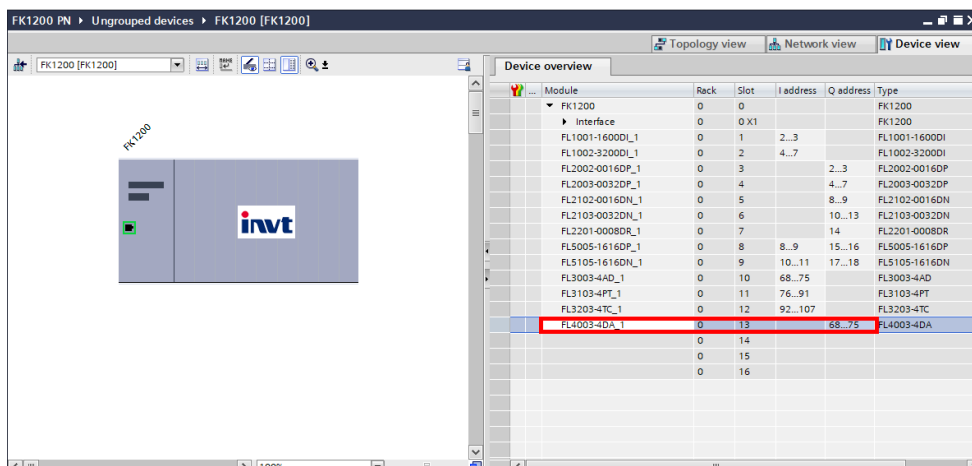

6.2.7 FL3103 (4PT) temperature detection module (Thermal resistor)

6.2.7.1 EtherCAT communication programming

1. Device import

Step 1 Add the FL3103-4PT device.

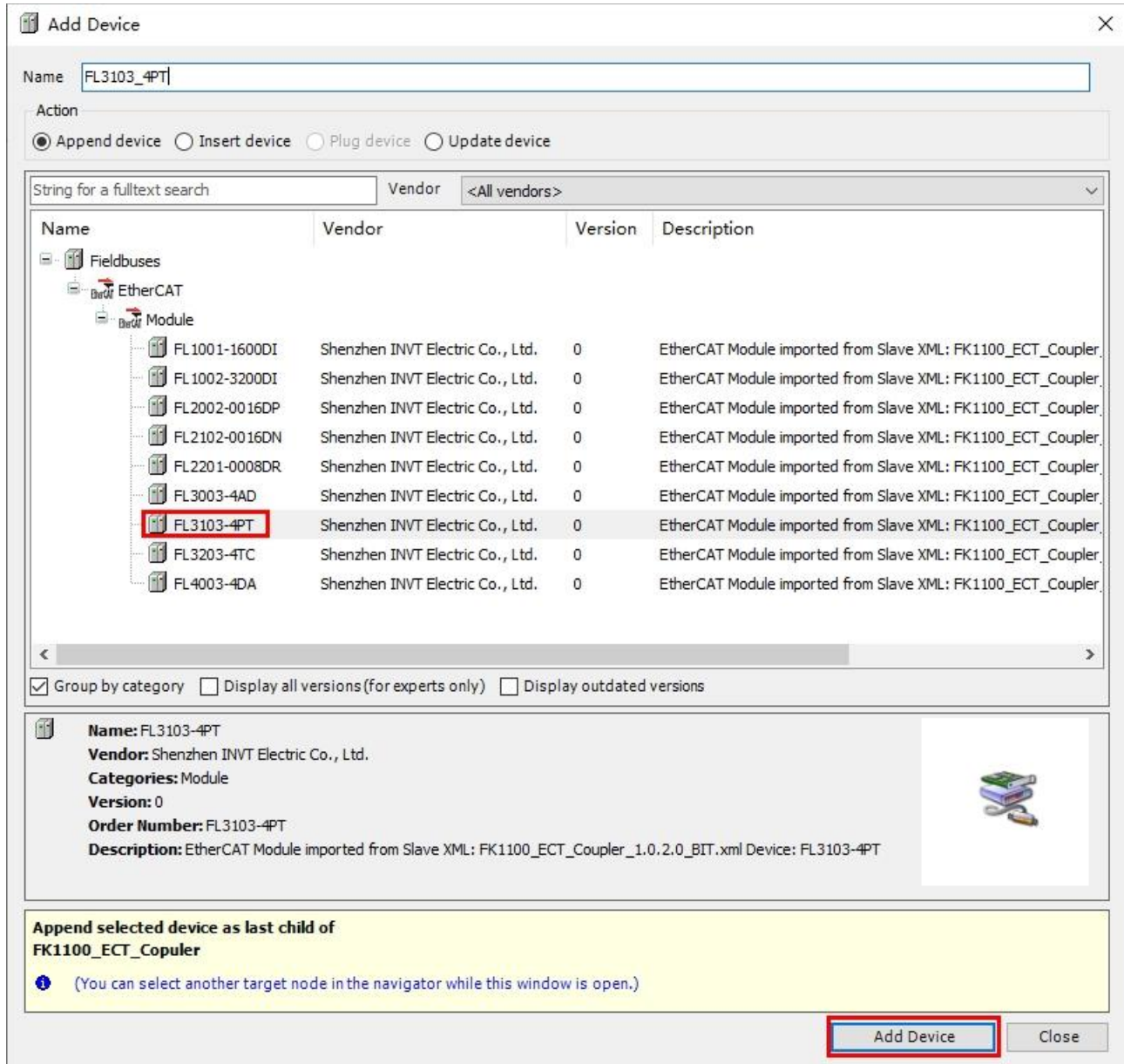

Step 2 Set the channel configuration, channel filter parameters, and temperature offset values based on actual needs in the startup parameters.

Line	Index:Subindex	Name	Value	Bit Length	Abort on Error	Jump to Line on Error	Next Line	Comment
1	16#8029:16#01	4PT Temp0 Cfg	128	8	<input type="checkbox"/>	<input type="checkbox"/>	0	4PT Temp0 Cfg
2	16#8029:16#02	4PT Temp1 Cfg	128	8	<input type="checkbox"/>	<input type="checkbox"/>	0	4PT Temp1 Cfg
3	16#8029:16#03	4PT Temp2 Cfg	128	8	<input type="checkbox"/>	<input type="checkbox"/>	0	4PT Temp2 Cfg
4	16#8029:16#04	4PT Temp3 Cfg	128	8	<input type="checkbox"/>	<input type="checkbox"/>	0	4PT Temp3 Cfg
5	16#8029:16#05	4PT Temp0 Filtr	8	8	<input type="checkbox"/>	<input type="checkbox"/>	0	4PT Temp0 Filtr
6	16#8029:16#06	4PT Temp1 Filtr	8	8	<input type="checkbox"/>	<input type="checkbox"/>	0	4PT Temp1 Filtr
7	16#8029:16#07	4PT Temp2 Filtr	8	8	<input type="checkbox"/>	<input type="checkbox"/>	0	4PT Temp2 Filtr
8	16#8029:16#08	4PT Temp3 Filtr	8	8	<input type="checkbox"/>	<input type="checkbox"/>	0	4PT Temp3 Filtr
9	16#8029:16#09	4PT Temp0 Offset	0	16	<input type="checkbox"/>	<input type="checkbox"/>	0	4PT Temp0 Offset
10	16#8029:16#0A	4PT Temp1 Offset	0	16	<input type="checkbox"/>	<input type="checkbox"/>	0	4PT Temp1 Offset
11	16#8029:16#0B	4PT Temp2 Offset	0	16	<input type="checkbox"/>	<input type="checkbox"/>	0	4PT Temp2 Offset
12	16#8029:16#0C	4PT Temp3 Offset	0	16	<input type="checkbox"/>	<input type="checkbox"/>	0	4PT Temp3 Offset
13	16#8029:16#0D	4PT Temp0 Up	0	16	<input type="checkbox"/>	<input type="checkbox"/>	0	4PT Temp0 Up
14	16#8029:16#0E	4PT Temp1 Up	0	16	<input type="checkbox"/>	<input type="checkbox"/>	0	4PT Temp1 Up
15	16#8029:16#0F	4PT Temp2 Up	0	16	<input type="checkbox"/>	<input type="checkbox"/>	0	4PT Temp2 Up
16	16#8029:16#10	4PT Temp3 Up	0	16	<input type="checkbox"/>	<input type="checkbox"/>	0	4PT Temp3 Up
17	16#8029:16#11	4PT Temp0 Low	0	16	<input type="checkbox"/>	<input type="checkbox"/>	0	4PT Temp0 Low
18	16#8029:16#12	4PT Temp1 Low	0	16	<input type="checkbox"/>	<input type="checkbox"/>	0	4PT Temp1 Low
19	16#8029:16#13	4PT Temp2 Low	0	16	<input type="checkbox"/>	<input type="checkbox"/>	0	4PT Temp2 Low
20	16#8029:16#14	4PT Temp3 Low	0	16	<input type="checkbox"/>	<input type="checkbox"/>	0	4PT Temp3 Low

Note: The temperature upper limit and lower limit are reserved parameters, and therefore they do not need to be set.

Step 3 Define *rValuePT0* and *rValuePT1* of the REAL type in the program.

```

VAR
  rValuePT0      : REAL;
  rValuePT1      : REAL;
END_VAR
    
```

Step 4 Choose **Module I/O Mapping**, map *rValuePT0* and *rValuePT1* to the corresponding input channels. You just need to use mapped variables in the program.

Variable	Mapping	Channel	Address	Type	Unit	Description
Application.PLC_PRG.rValuePT0		Temp0	%ID12	REAL		Temp0
Application.PLC_PRG.rValuePT1		Temp1	%ID13	REAL		Temp1
		Temp2	%ID14	REAL		Temp2
		Temp3	%ID15	REAL		Temp3
		Temp0_ErrId	%IW32	UINT		Temp0_ErrId
		Temp1_ErrId	%IW33	UINT		Temp1_ErrId
		Temp2_ErrId	%IW34	UINT		Temp2_ErrId
		Temp3_ErrId	%IW35	UINT		Temp3_ErrId

2. Parameter description

Name	Type	Description
Temp0 Cfg	USINT	Configuration parameter for channel 0. bit0: Channel enabling control. (0: Disable. 1: Enable.) bit1: Over-range detection enabling control. (0: Disable. 1: Enable.) bit3-bit2: Thermal resistor wire system. (0b00: Two-wire. 0b01: Three-wire. 0b10: Four-wire) bit4: Temperature unit. (0: °C. 1: °F.)

Name	Type	Description
		bit7–bit5: Channel conversion mode. (0b000: Reserved 0b001: PT100 0b010: PT500 0b011: Reserved 0b100: PT1000 0b101: Reserved 0b110: Reserved 0b111: CU100)
Temp1 Cfg	USINT	Configuration parameter for channel 1. The parameter setting is consistent with that for channel 0.
Temp2 Cfg	USINT	Configuration parameter for channel 2. The parameter setting is consistent with that for channel 0.
Temp3 Cfg	USINT	Configuration parameter for channel 3. The parameter setting is consistent with that for channel 0.
Temp0 Filt	USINT	Filter parameter for channel 0. Range: 1–255. A greater value indicates better filter effect but greater lagging.
Temp1 Filt	USINT	Filter parameter for channel 1. The filter parameter setting is consistent with that for channel 0.
Temp2 Filt	USINT	Filter parameter for channel 2. The filter parameter setting is consistent with that for channel 0.
Temp3 Filt	USINT	Filter parameter for channel 3. The filter parameter setting is consistent with that for channel 0.
Temp0 Offset	INT	Temperature offset value for channel 0. The value has been amplified by 10 times, with 999 representing 99.9. Detection value = Actually measured value + Offset value
Temp1 Offset	INT	Temperature offset value for channel 1. The temperature offset value is consistent with that for channel 0.
Temp2 Offset	INT	Temperature offset value for channel 2. The temperature offset value is consistent with that for channel 0.
Temp3 Offset	INT	Temperature offset value for channel 3. The temperature offset value is consistent with that for channel 0.
Temp0 Up	INT	Temperature upper limit for channel 0. Reserved. The sensor provided limit value is used.
Temp1 Up	INT	Temperature upper limit for channel 1. Reserved. The sensor provided limit value is used.
Temp2 Up	INT	Temperature upper limit for channel 2. Reserved. The sensor provided limit value is used.
Temp3 Up	INT	Temperature upper limit for channel 3. Reserved. The sensor provided limit value is used.
Temp0 Low	INT	Temperature lower limit for channel 0. Reserved.

Name	Type	Description
		The sensor provided limit value is used.
Temp1 Low	INT	Temperature lower limit for channel 1. Reserved. The sensor provided limit value is used.
Temp2 Low	INT	Temperature lower limit for channel 2. Reserved. The sensor provided limit value is used.
Temp3 Low	INT	Temperature lower limit for channel 3. Reserved. The sensor provided limit value is used.
Temp0	REAL	Conversion value for channel 0.
Temp1	REAL	Conversion value for channel 1.
Temp2	REAL	Conversion value for channel 2.
Temp3	REAL	Conversion value for channel 3.
Temp0_Errld	UINT	Fault code for channel 0.
Temp1_Errld	UINT	Fault code for channel 1.
Temp2_Errld	UINT	Fault code for channel 2.
Temp3_Errld	UINT	Fault code for channel 3.
HW Version	UINT	Module hardware version number
FPGA Version	UINT	Module FPGA software version number

6.2.7.2 PROFINET communication programming

Step 1 In the **Device view** interface, add **FL3103-4PT**, double click **FL3103-4PT** under **Module**, choose **Properties > General > Module parameters**, and then set module initialization parameters.

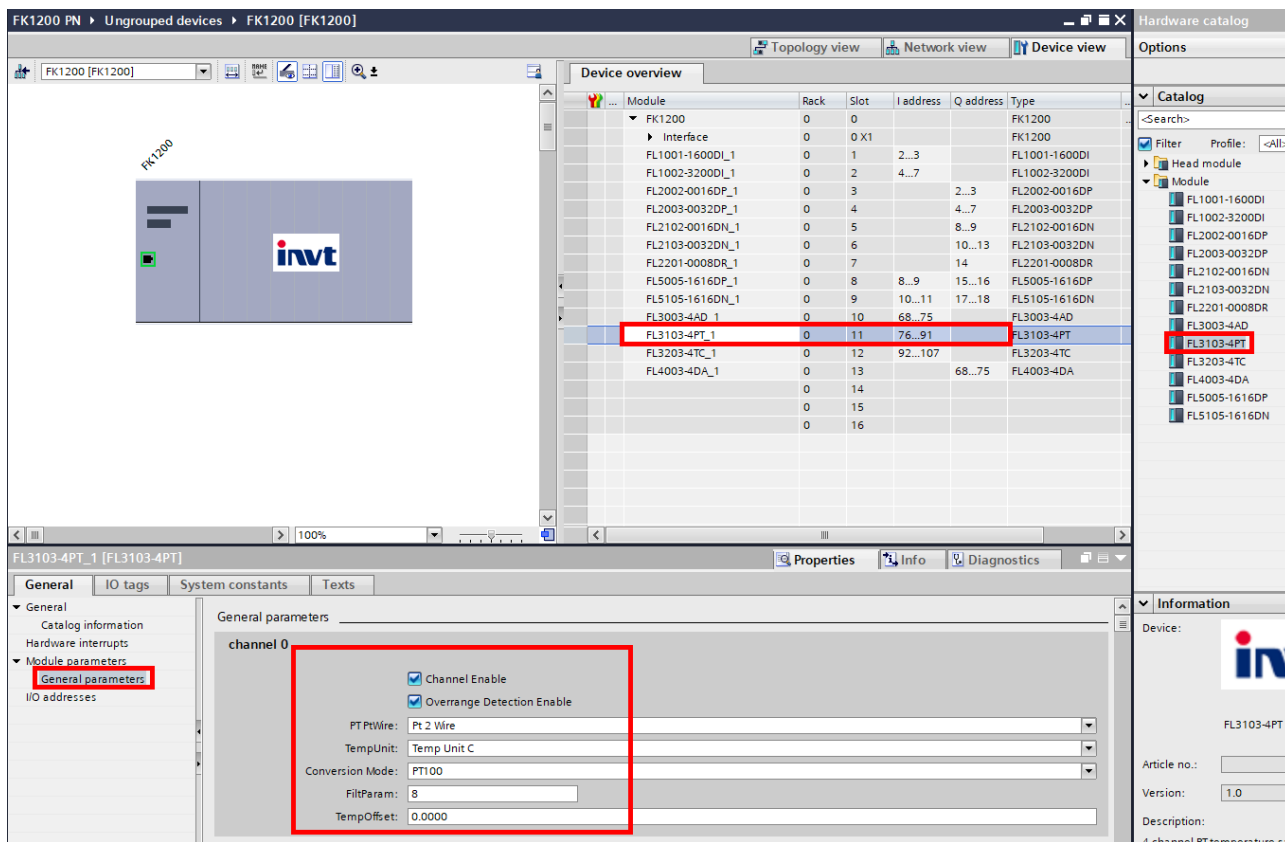

Step 2 Obtain sampling values through I addresses.

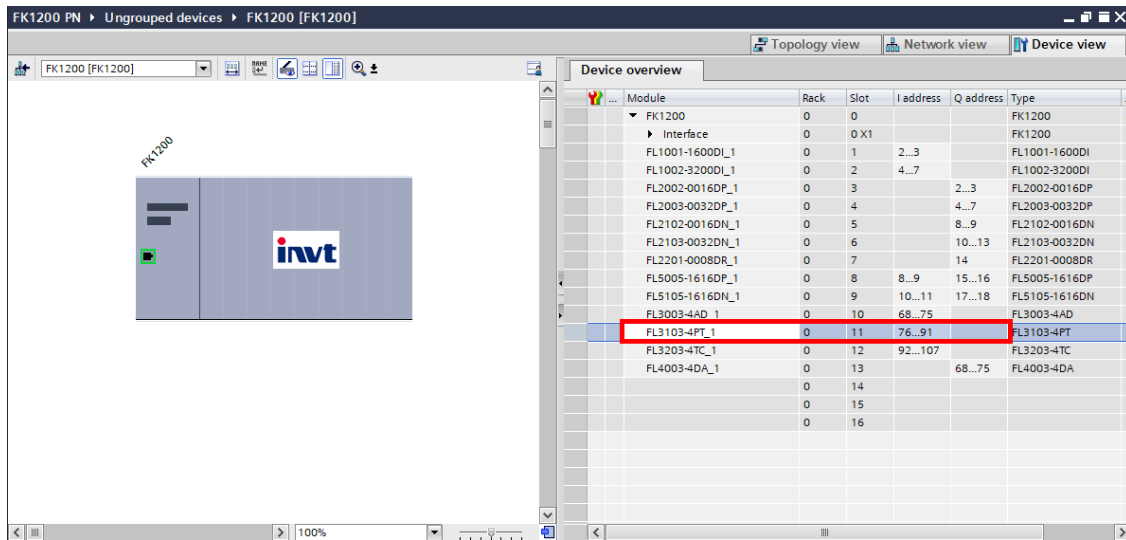

6.2.8 FL3203 (4TC) temperature detection module (Thermocouple)

6.2.8.1 EtherCAT communication programming

1. Programming instance

Step 1 Add the FL3201-4TC device.

Add Device [Close]

Name:

Action: Append device Insert device Plug device Update device

String for a fulltext search: Vendor: <All vendors>

Name	Vendor	Version	Description
Fieldbuses			
EtherCAT			
Module			
FL1001-1600DI	Shenzhen INVT Electric Co., Ltd.	0	EtherCAT Module imported from Slave XML: FK1100_ECT_Coupler
FL1002-3200DI	Shenzhen INVT Electric Co., Ltd.	0	EtherCAT Module imported from Slave XML: FK1100_ECT_Coupler
FL2002-0016DP	Shenzhen INVT Electric Co., Ltd.	0	EtherCAT Module imported from Slave XML: FK1100_ECT_Coupler
FL2102-0016DN	Shenzhen INVT Electric Co., Ltd.	0	EtherCAT Module imported from Slave XML: FK1100_ECT_Coupler
FL2201-0008DR	Shenzhen INVT Electric Co., Ltd.	0	EtherCAT Module imported from Slave XML: FK1100_ECT_Coupler
FL3003-4AD	Shenzhen INVT Electric Co., Ltd.	0	EtherCAT Module imported from Slave XML: FK1100_ECT_Coupler
FL3103-4PT	Shenzhen INVT Electric Co., Ltd.	0	EtherCAT Module imported from Slave XML: FK1100_ECT_Coupler
FL3203-4TC	Shenzhen INVT Electric Co., Ltd.	0	EtherCAT Module imported from Slave XML: FK1100_ECT_Coupler
FL4003-4DA	Shenzhen INVT Electric Co., Ltd.	0	EtherCAT Module imported from Slave XML: FK1100_ECT_Coupler

Group by category Display all versions (for experts only) Display outdated versions

Name: FL3203-4TC
Vendor: Shenzhen INVT Electric Co., Ltd.
Categories: Module
Version: 0
Order Number: FL3203-4TC
Description: EtherCAT Module imported from Slave XML: FK1100_ECT_Coupler_1.0.2.0_BIT.xml Device: FL3203-4TC

Append selected device as last child of FK1100_ECT_Copuler
 (You can select another target node in the navigator while this window is open.)

Add Device [Close]

Step 2 Set the channel configuration, channel filter parameters, and temperature offset values based on actual needs in the startup parameters.

Line	Index:Subindex	Name	Value	Bit Length	Abort on Error	Jump to Line on Error	Next Line	Comment
1	16#802D:16#01	4TC Temp0 Cfg	96	8	<input type="checkbox"/>	<input type="checkbox"/>	0	4TC Temp0 Cfg
2	16#802D:16#02	4TC Temp1 Cfg	96	8	<input type="checkbox"/>	<input type="checkbox"/>	0	4TC Temp1 Cfg
3	16#802D:16#03	4TC Temp2 Cfg	96	8	<input type="checkbox"/>	<input type="checkbox"/>	0	4TC Temp2 Cfg
4	16#802D:16#04	4TC Temp3 Cfg	96	8	<input type="checkbox"/>	<input type="checkbox"/>	0	4TC Temp3 Cfg
5	16#802D:16#05	4TC Temp0 Filtr	8	8	<input type="checkbox"/>	<input type="checkbox"/>	0	4TC Temp0 Filtr
6	16#802D:16#06	4TC Temp1 Filtr	8	8	<input type="checkbox"/>	<input type="checkbox"/>	0	4TC Temp1 Filtr
7	16#802D:16#07	4TC Temp2 Filtr	8	8	<input type="checkbox"/>	<input type="checkbox"/>	0	4TC Temp2 Filtr
8	16#802D:16#08	4TC Temp3 Filtr	8	8	<input type="checkbox"/>	<input type="checkbox"/>	0	4TC Temp3 Filtr
9	16#802D:16#09	4TC Temp0 Offset	0	16	<input type="checkbox"/>	<input type="checkbox"/>	0	4TC Temp0 Offset
10	16#802D:16#0A	4TC Temp1 Offset	0	16	<input type="checkbox"/>	<input type="checkbox"/>	0	4TC Temp1 Offset
11	16#802D:16#0B	4TC Temp2 Offset	0	16	<input type="checkbox"/>	<input type="checkbox"/>	0	4TC Temp2 Offset
12	16#802D:16#0C	4TC Temp3 Offset	0	16	<input type="checkbox"/>	<input type="checkbox"/>	0	4TC Temp3 Offset
13	16#802D:16#0D	4TC Temp0 Up	0	16	<input type="checkbox"/>	<input type="checkbox"/>	0	4TC Temp0 Up
14	16#802D:16#0E	4TC Temp1 Up	0	16	<input type="checkbox"/>	<input type="checkbox"/>	0	4TC Temp1 Up
15	16#802D:16#0F	4TC Temp2 Up	0	16	<input type="checkbox"/>	<input type="checkbox"/>	0	4TC Temp2 Up
16	16#802D:16#10	4TC Temp3 Up	0	16	<input type="checkbox"/>	<input type="checkbox"/>	0	4TC Temp3 Up
17	16#802D:16#11	4TC Temp0 Low	0	16	<input type="checkbox"/>	<input type="checkbox"/>	0	4TC Temp0 Low
18	16#802D:16#12	4TC Temp1 Low	0	16	<input type="checkbox"/>	<input type="checkbox"/>	0	4TC Temp1 Low
19	16#802D:16#13	4TC Temp2 Low	0	16	<input type="checkbox"/>	<input type="checkbox"/>	0	4TC Temp2 Low
20	16#802D:16#14	4TC Temp3 Low	0	16	<input type="checkbox"/>	<input type="checkbox"/>	0	4TC Temp3 Low

Note: The temperature upper limit and lower limit are reserved parameters, and therefore they do not need to be set.

Step 3 Define *rValueTC0* and *rValueTC1* of the REAL type in the program.

```

VAR
    rValueTC0    : REAL;
    rValueTC1    : REAL;

END_VAR
    
```

Step 4 Choose **Module I/O Mapping**, map *rValueTC0* and *rValueTC1* to the corresponding input channels. You just need to use mapped variables in the program.

Variable	Mapping	Channel	Address	Type	Unit	Description
Application.PLC_PRG.rValueTC0		Temp0	%ID18	REAL		Temp0
Application.PLC_PRG.rValueTC1		Temp1	%ID19	REAL		Temp1
		Temp2	%ID20	REAL		Temp2
		Temp3	%ID21	REAL		Temp3
		Temp0_ErrId	%IW44	UINT		Temp0_ErrId
		Temp1_ErrId	%IW45	UINT		Temp1_ErrId
		Temp2_ErrId	%IW46	UINT		Temp2_ErrId
		Temp3_ErrId	%IW47	UINT		Temp3_ErrId

2. Parameter description

Name	Type	Description
Temp0 Cfg	USINT	Configuration parameter for channel 0. bit0: Channel enabling control. (0: Disable. 1: Enable.) bit1: Over-range detection enabling control. (0: Disable. 1: Enable.) bit3–bit2: Reserved bit4: Temperature unit. (0: °C. 1: °F.) bit7–bit5: Channel conversion mode.

Name	Type	Description
		(0b000: Thermocouple of type B. 0b001: Thermocouple of type E. 0b010: Thermocouple of type J. 0b011: Thermocouple of type K. 0b100: Thermocouple of type N. 0b101: Thermocouple of type R. 0b110: Thermocouple of type S. 0b111: Thermocouple of type T.
Temp1 Cfg	USINT	Configuration parameter for channel 1. The parameter setting is consistent with that for channel 0.
Temp2 Cfg	USINT	Configuration parameter for channel 2. The parameter setting is consistent with that for channel 0.
Temp3 Cfg	USINT	Configuration parameter for channel 3. The parameter setting is consistent with that for channel 0.
Temp0 Filt	USINT	Filter parameter for channel 0. Range: 1–255. A greater value indicates better filter effect but greater lagging.
Temp1 Filt	USINT	Filter parameter for channel 1. The filter parameter setting is consistent with that for channel 0.
Temp2 Filt	USINT	Filter parameter for channel 2. The filter parameter setting is consistent with that for channel 0.
Temp3 Filt	USINT	Filter parameter for channel 3. The filter parameter setting is consistent with that for channel 0.
Temp0 Offset	INT	Temperature offset value for channel 0. (The value has been amplified by 10 times, with 999 representing 99.9.) Detection value = Actually measured value + Offset value
Temp1 Offset	INT	Same as the temperature offset value for channel 0.
Temp2 Offset	INT	Same as the temperature offset value for channel 1.
Temp3 Offset	INT	Same as the temperature offset value for channel 2.
Temp0 Up	INT	Temperature upper limit for channel 0. Reserved. The sensor provided limit value is used.
Temp1 Up	INT	Temperature upper limit for channel 1. Reserved. The sensor provided limit value is used.
Temp2 Up	INT	Temperature upper limit for channel 2. Reserved. The sensor provided limit value is used.
Temp3 Up	INT	Temperature upper limit for channel 3. Reserved. The sensor provided limit value is used.
Temp0 Low	INT	Temperature lower limit for channel 0. Reserved. The sensor provided limit value is used.
Temp1 Low	INT	Temperature lower limit for channel 1. Reserved. The sensor provided limit value is used.
Temp2 Low	INT	Temperature lower limit for channel 2. Reserved. The sensor provided limit value is used.
Temp3 Low	INT	Temperature lower limit for channel 3. Reserved. The

Name	Type	Description
		sensor provided limit value is used.
Temp0	REAL	Conversion value for channel 0.
Temp1	REAL	Conversion value for channel 1.
Temp2	REAL	Conversion value for channel 2.
Temp3	REAL	Conversion value for channel 3.
Temp0_ErrId	UINT	Fault code for channel 0.
Temp1_ErrId	UINT	Fault code for channel 1.
Temp2_ErrId	UINT	Fault code for channel 2.
Temp3_ErrId	UINT	Fault code for channel 3.
HW Version	UINT	Module hardware version number
FPGA Version	UINT	Module FPGA software version number

6.2.8.2 PROFINET communication programming

Step 1 In the **Device view** interface, add **FL3203-4TC**, double click **FL3203-4TC** under **Module**, choose **Properties > General > Module parameters**, and then set module initialization parameters.

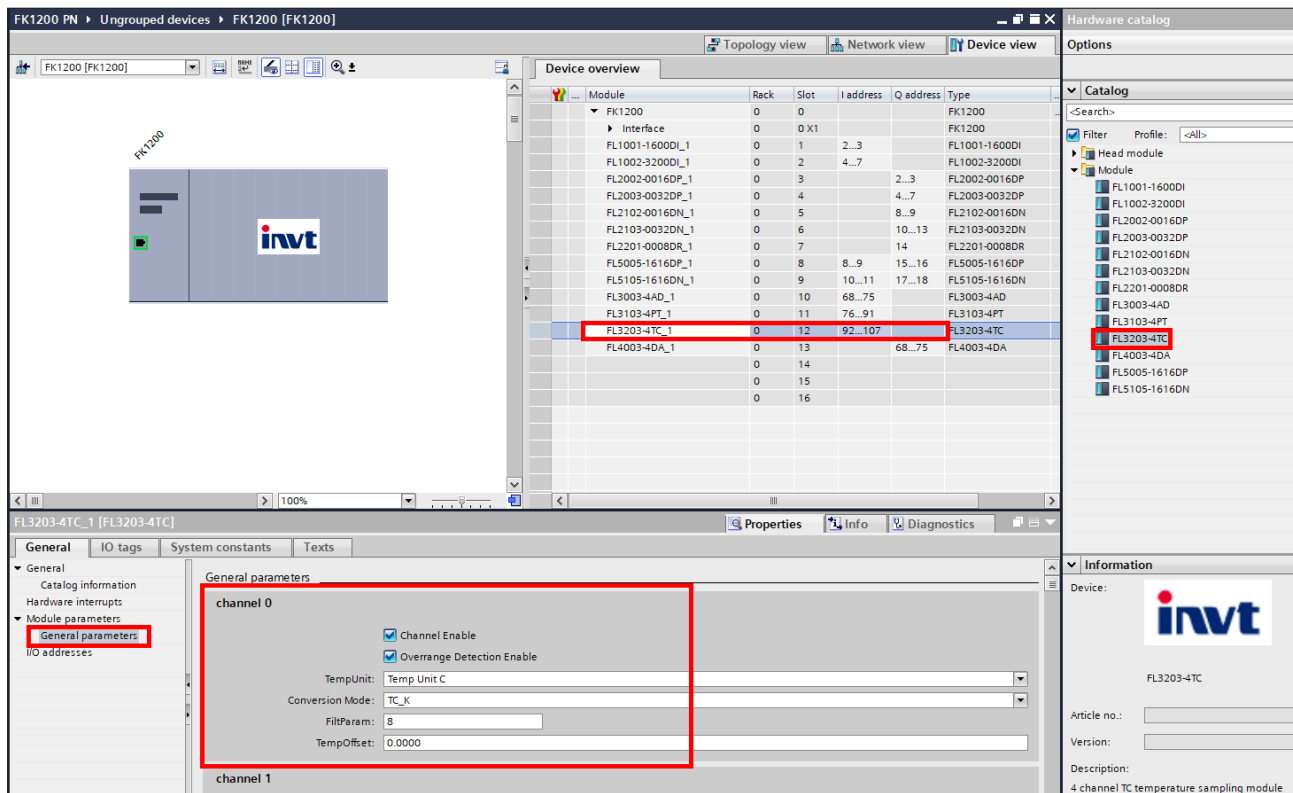

Step 2 Obtain sampling values through I addresses.

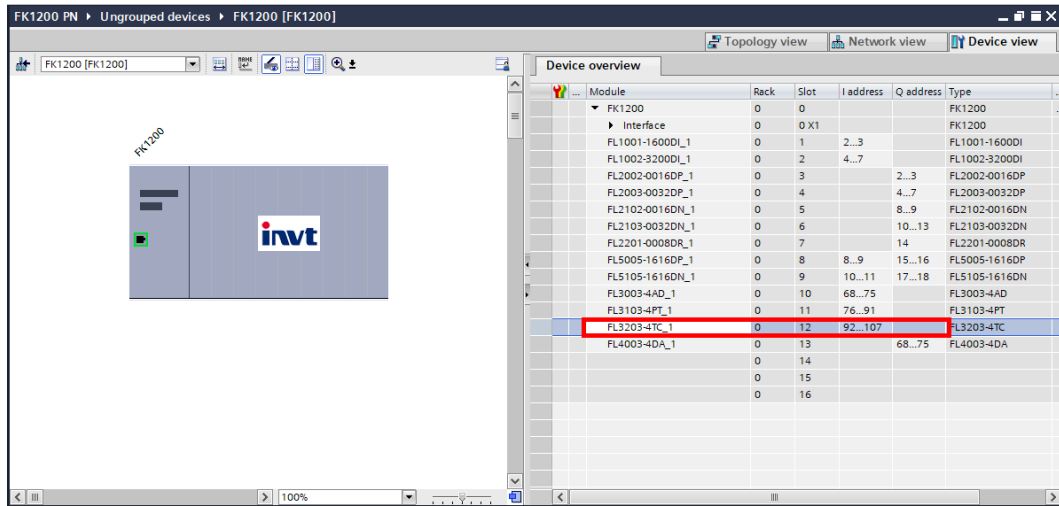

7 Fault code

Fault code	Fault code (in hex.)	Fault type	Solution
1	0x0001	Module configuration fault	Ensure the correct mapping between module network configuration and physical configuration.
2	0x0002	Incorrect module parameter setting	Ensure that module parameter settings are correct.
3	0x0003	Module output port power supply fault	Ensure that the module output port power supply is normal.
4	0x0004	Module output fault	Ensure that the module output port load is within the specified range.
18	0x0012	Incorrect parameter setting for channel 0	Ensure that the parameter settings for channel 0 are correct.
20	0x0014	Output fault on channel 0	Ensure that the output of channel 0 has no short circuit or open circuit.
21	0x0015	Signal source open circuit fault on channel 0	Ensure that the signal source physical connection of channel 0 is normal.
22	0x0016	Sampling signal limit exceeding fault on channel 0	Ensure that the sampling signal on channel 0 does not exceed the chip limit.
23	0x0017	Sampling signal measurement upper limit exceeding fault on channel 0	Ensure that the sampling signal on channel 0 does not exceed the measurement upper limit.
24	0x0018	Sampling signal measurement lower limit exceeding fault on channel 0	Ensure that the sampling signal on channel 0 does not exceed the measurement lower limit.
34	0x0022	Incorrect parameter setting for channel 1	Ensure that the parameter settings for channel 1 are correct.
36	0x0024	Output fault on channel 1	Ensure that the output of channel 1 has no short circuit or open circuit.
37	0x0025	Signal source open circuit fault on channel 1	Ensure that the signal source physical connection of channel 1 is normal.
38	0x0026	Sampling signal limit exceeding fault on channel 1	Ensure that the sampling signal on channel 1 does not exceed the chip limit.
39	0x0027	Sampling signal measurement upper limit exceeding fault on channel 1	Ensure that the sampling signal on channel 1 does not exceed the measurement upper limit.
40	0x0028	Sampling signal measurement lower limit exceeding fault on channel 1	Ensure that the sampling signal on channel 1 does not exceed the measurement lower limit.
50	0x0032	Incorrect parameter setting for channel 2	Ensure that the parameter settings for channel 2 are correct.
52	0x0034	Output fault on channel 2	Ensure that the output of channel 2 has no short circuit or open circuit.
53	0x0035	Signal source open circuit fault	Ensure that the signal source physical

Fault code	Fault code (in hex.)	Fault type	Solution
		on channel 2	connection of channel 2 is normal.
54	0x0036	Sampling signal limit exceeding fault on channel 2	Ensure that the sampling signal on channel 2 does not exceed the chip limit.
55	0x0037	Sampling signal measurement upper limit exceeding fault on channel 2	Ensure that the sampling signal on channel 2 does not exceed the measurement upper limit.
56	0x0038	Sampling signal measurement lower limit exceeding fault on channel 2	Ensure that the sampling signal on channel 2 does not exceed the measurement lower limit.
66	0x0042	Incorrect parameter setting for channel 3	Ensure that the parameter settings for channel 3 are correct.
68	0x0044	Output fault on channel 3	Ensure that the output of channel 3 has no short circuit or open circuit.
69	0x0045	Signal source open circuit fault on channel 3	Ensure that the signal source physical connection of channel 3 is normal.
70	0x0046	Sampling signal limit exceeding fault on channel 3	Ensure that the sampling signal on channel 3 does not exceed the chip limit.
71	0x0047	Sampling signal measurement upper limit exceeding fault on channel 3	Ensure that the sampling signal on channel 3 does not exceed the measurement upper limit.
72	0x0048	Sampling signal measurement lower limit exceeding fault on channel 3	Ensure that the sampling signal on channel 3 does not exceed the measurement lower limit.

Your Trusted Industry Automation Solution Provider



Shenzhen INVT Electric Co., Ltd.

Address: INVT Guangming Technology Building, Songbai Road, Matian,
Guangming District, Shenzhen, China

INVT Power Electronics (Suzhou) Co., Ltd.

Address: No. 1 Kunlun Mountain Road, Science & Technology Town,
Gaoxin District, Suzhou, Jiangsu, China

Website: www.invt.com



INVT mobile website



INVT e-manual



6 6 0 0 1 - 0 1 1 9 7